

Ronix[®]

Premium Quality

HIGH PRESSURE WASHER RP-U100E

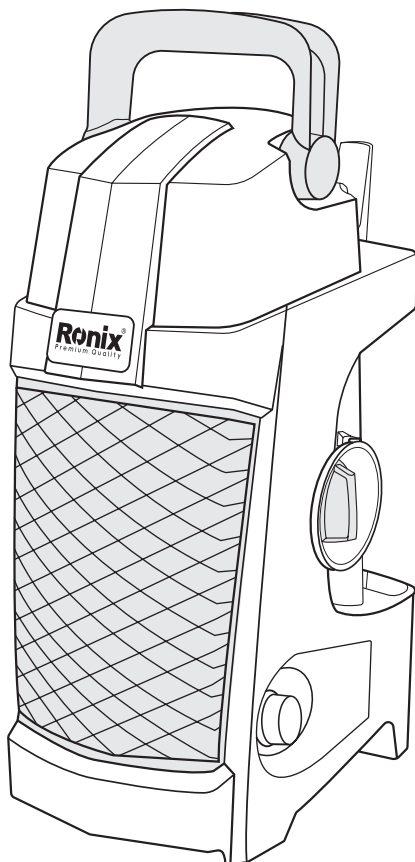

SPECIFICATIONS

Model	RP-U100E
Voltage	220-240V
Frequency	50-60Hz
Power	1400W
Motor Type	Universal
Max Pressure	100Bar
Max Rated Flow	6.5L/Min
Detergent Tank Type	External
Weight	5.53kg
Includes	Quick connector water inlet nut Adjustable and turbo lances 5-meter high-pressure PVC hose Detergent tank High-pressure gun
Supplied in	Ronix color box

PARTS LIST

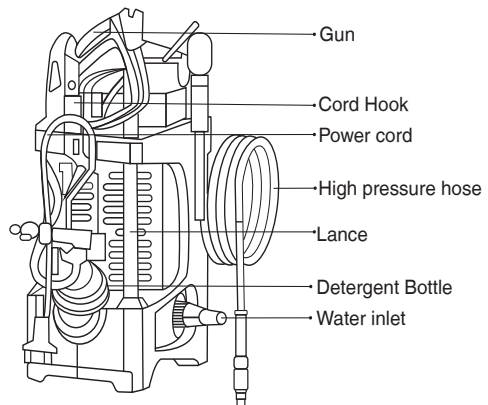
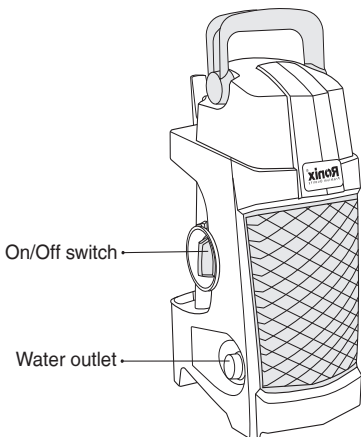

■ PURPOSE

- The high pressure cleaner is designed to clean vehicles, machines, buildings, facades, etc.
- In the private sector.

■ AREAS OF APPLICATION

- Never use the machine in potentially explosive areas under any circumstances.
- The operating temperature must be between 0 and +40°C
- The machine consists of an assembly with a pump, which is encased in a shock absorbing housing. For an optimal working position the machine comes with a lance and a non-slip
- Handle grip. Whose shape and configuration comply with the appliance regulations.
- Do not cover or modify the lance or the spray nozzles in any way.
- The high pressure cleaner is designed to be used with cold or lukewarm (max.40°C); higher temperatures can damage the pump.
- Do not use water that is dirty, gritty or contains any chemical products, as these could impair operation and shorten the life of the machine.
- Accessories can be used to carry out work with foam cleaners, sand spraying.



IMPORTANT:

This machine is not suitable for connection to the potable water mains.

IMPORTANT SAFETY INSTRUCTIONS



WARNING!

This appliance is not intended for use by children or other persons without assistance or supervision if their physical, sensory or mental capabilities prevent them from using it safely. Before starting up your machine please check it carefully for any defects. If you find any, do not

start up your machine and contact your distributor.

■ **ESPECIALLY CHECK**

The insulation of the power cord should be faultless and without any cracks. If the power cord is damaged, an authorized distributor should replace it.

WARNING!

- Do not use this appliance without reading this instruction sheets.
- The electric supply connection shall be made by a qualified electrician and comply with IEC60364-1.
- The electric supply to this appliance should include either a residual current device that will interrupt the supply if the leakage current to earth exceeds 30Ma for 30ms or device that will interrupt the earth circuit.

WARNING!

This appliance has been designed for use with the cleaning agent supplied or recommended by the manufacturer. The use of other cleaning agents or chemical may adversely affect the safety of the appliance.

WARNING!

Do not use the appliance within range of person unless they wear protective clothing.

WARNING!

- High pressure jets can be dangerous if subject to misuse. The jet must not be directed at persons, live electrical equipment or the appliance itself.
- do not direct the jet against yourself or others in order to clean clothes or foot-wear,
- risk of explosion – do not spray flammable liquids.
- disconnect from the electrical power supply before carrying out user maintenance.
- high pressure cleaners shall not be used by children or untrained personnel.

-to ensure appliance safety, use only original spare parts from the manufacturer or approved by the manufacturer.

⚠ WARNING!

Water that has flown through backflow preventers is considered to be non-potable.

⚠ WARNING!

The machine shall be disconnected from its power source during cleaning or maintenance and when replacing parts for mains operated machines by removing the plug from the socket-outlet.

⚠ WARNING!

High pressure hoses, fittings and couplings are important for safety of the appliance. Use only hoses, fitting and couplings recommended by the manufacturer.

- do not use the appliance if a supply cord or important parts of the appliance are damaged, e.g.

Safety devices, high pressure hoses, trigger gun.

⚠ WARNING!

If an extension cord is used, the plug and socket must be of watertight construction.

⚠ WARNING!

Inadequate extension cords can be dangerous.

This high pressure washer must not be used at temperatures below 0°C.

⚠ WARNING!

- Cord on drums should always be completely un-winded to prevent the cord from overheating.

- If an extension cord is used, the plug and socket must be of watertight construction.

- Inadequate extension cords and be dangerous.
- Power cord connections should be kept dry and off the ground.
- if the power cord is damaged, it must be replaced by the manufacturer or his service agent or similarly qualified person in order to avoid a hazard.
- Keep the machine on a stable and flat surface during operation, handling, transportation and strong. sudden overturn of machine will cause injury to body.

In the event of accident or breakdown, switch off the machine immediately. (e.g. contact with detergent: rinse with an abundance of clean water)

ATTENTION:

Through poor conditions of the electrical MAINS, shortly voltage drops can appear when starting the EQUIPMENT. this can influence other equipment (e.g. Blinking of a lamp). If the MAINS-IMPEDANCE $Z_{max} < 0.335 \text{ OMH}$, such disturbances are not expected. (in case of need, you may contact your local supply authority for further information.)

WARNING!

ELECTRICAL SHOCK HAZARD

Improper connection of the equipment –grounding conductor can result in a risk of electrical shock. Check with a qualified electrician or service person if you are unsure if an outlet is properly grounded. **DO NOT** modify the plug provided with the appliance to fit an outlet, have a proper outlet installed by a qualified electrician.

IMPOTANT:

Only use water without any impurities. If there is a risk of running sands in the inlet water (i.e. from your own well), an additional filter should be mounted.

- Safety devices
- The unloader valve can reduce pressure if it exceeds pre-set values.

the spray gun features a locking device. When the pawl is activated, the spray gun cannot be operated.

- Thermal sensor

A thermal sensor protects the motor against overloading. Machine will restart after a few minutes when the thermal sensor has cooled.

ASSEMBLY

-Position the washer as NEAR as possible to the water supply.

The washer must be used standing on a secure, stable, positioned as shown.



- Fit the lance into the gun and rotate it until the two parts are completely locked.

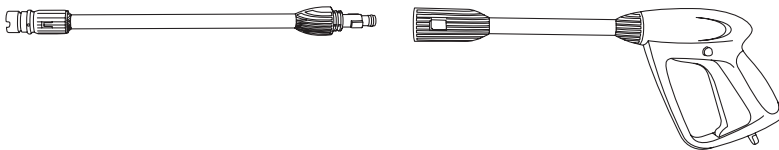

- Connect the gun to high pressure hose.

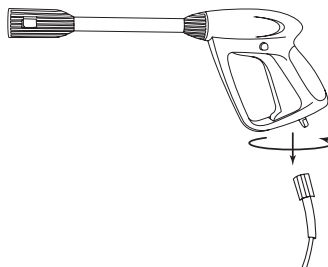

- Connect the high pressure hose to the water outlet on the washer.

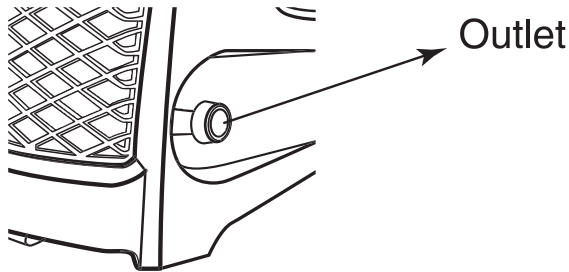

- Connect the water supply hose to female coupler. Then connect to the water inlet of the washer. The supply hose must have an internal diameter of at least 13mm (1/2 in) and must be reinforced. the water supply must be at least equal to the washer delivery capacity.

OPERATION

- Turn on the water supply tap fully.
- Release the safety lock then press the trigger for a few seconds to allow air to escape and discharge residual pressure in the hose.
- Keeping the trigger pressed push the switch to start the motor.
- When re-starting the motor, always keep the trigger pressed.

NOTE:

THE MOTOR ONLY RUNS WHEN THE TRIGGER IS OPERATED.

.CORRECT USE OF STANDARD ACCESSORIES

- The washer is equipped with adjustable nozzle.
- Jet adjustment from pencil to fan.





WARNING!

DO NOT ADJUST THE NOZZLE WHILE THE TRIGGER IS SQUEEZED.

RECOMMENDED CLEANING PROCEDURE

- Dissolve dirt by applying detergent with the fan jet to the dry surface. on vertical surfaces, work from the bottom upwards. leave the detergent to act for 1 to 2 minutes, but do not allow to dry out. Apply the high from the surface, working from the bottom upwards.
- Avoid allowing the rinsing water to run on to unwanted surfaces.

STORAGE

- Switch off the washer.
- Turn off the water supply tap.
- After use, the detergent residuals should be removed from the tank.
- Discharge residual pressure by pressing the trigger until no more water comes out of the lance nozzle.
- Engage the gun safety lock.
- Remove the plug from the socket.
- Operate the washer with non-corrosive /non-toxic antifreeze before storing for the winter.



WARNING!

BEFORE REUSING, COMPLETELY FLUSH THE UNIT OUT WITH PLAIN WATER. ANTI-FREEZE CAN DAMAGE PAINTWORK SO YOU MUST ENSURE THERE IS NO ANTI-FREEZE LEFT IN THE SYSTEM BEFORE USING IT AGAIN.

MAINTENANCE



CAUTION:

Before working on the washer, disconnect the plug from the power supply socket.

- to ensure good performance. check and clean the suction and detergent filters after every 50 hours of operation.
- clean the nozzle with tool provided. remove the lance from the gun, remove any dirt from the nozzle hole and rinse.

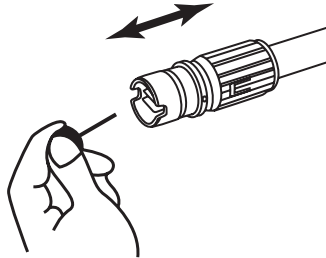

TROUBLESHOOTING

Disconnect from the electrical power supply before carrying out user maintenance or checking is correct functioning. To avoid unnecessary disappointments, you should check the following before contacting the service organization.

Ronix[®]
Premium Quality