

Ronix[®]

Premium Quality

MULTI-FUNCTIONAL CLEANING EQUIPMENT

RP-2100

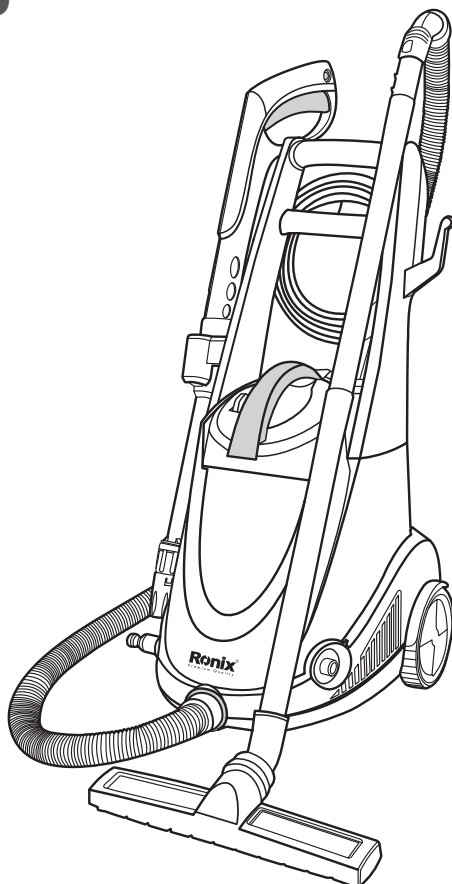

www.ronixtools.com

12
MONTHS
GUARANTY

FREE
DELIVERY

BANK
SPARE PARTS

CALL
CENTER
021 61904

SPECIFICATIONS

Model	RP-2100
High Pressure Washer	
Voltage	220V
Power	1400W
Max Pressure	10MPA
Max Flow	6L/Min
Vacuum Cleaner	
Voltage	220V
Power	1000W
Max Vacuum Degree	16KPA
Max Air Flow	2.4m3/min
Max suction Power	280W
Weight	12 Kg

PARTS LIST

- 1) Handle
- 2) Power cord hook
- 3) High-pressure hose hook
- 4) Dust compartment
- 5) Water outlet
- 6) Blow air outlet
- 7) Wheel
- 8) Trigger gun
- 9) High-pressure hose
- 10) Triangle wet and dry brush
- 11) Trigger gun holder
- 12) Power switch
- 13) Nozzle
- 14) Soft tube
- 15) Water inlet
- 16) Power cord
- 17) Extension tube

- 18) Detergent bottle
- 19) Wet and dry floor brush
- 20) Crevice Nozzle
- 21) Round Brush
- 22) L Connector

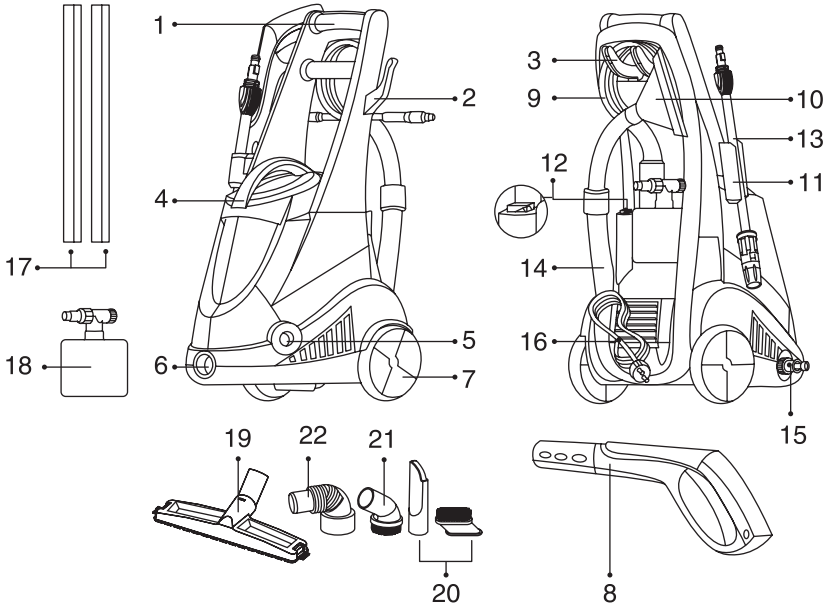

SAVE THESE INSTRUCTIONS

Please read and comply with these original instructions prior to the initial operation of your appliance and store them for later use or subsequent owners.

Apart from the notes contained herein the general safety provisions and rules for the prevention of accidents of the legislator must be observed.

Warnings and notes that are attached on the appliance provide important notes for the safe operation.

■ HAZARD LEVELS

DANGER:

Pointer to immediate danger, if not avoided, which leads to severe injuries or death.

WARNING!

Pointer to a possibly dangerous situation, if not avoided, which can lead to severe injuries or death.

CAUTION:

Pointer to a possibly dangerous situation, if not avoided, which can lead to minor injuries.

ATTENTION:

Pointer to a possibly dangerous situation, which can lead to property damage.

■ ELECTRIC COMPONENTS

DANGER:

Risk of electric shock.

Never touch the mains plug and the socket with wet hands.

Check the power cord with mains Plug for damage prior to every use. Do not use the machine if a supply cord or important parts of the machine are damaged, e.g. safety devices, high pressure hoses, trigger gun.

All current-conducting parts in the working area must be protected against jet water.

The mains plug and the coupling of an extension cable must be watertight and must never lie in water. Moreover, the coupling may never lie on the ground. The use of cable reels that ensure that the sockets are at least 60 mm above the ground is commended.

Make sure that the power cord or extension cable is not damaged by

running over, pinching, dragging or the like. Protect the power cords from heat, oil, and sharp edges.

Always switch off the mains disconnecting switch when leaving the appliance unattended.

⚠ WARNING!

An unsuitable electrical extension cable can be hazardous. Only use an electrical extension cable which has been approved and labeled for this purpose and has an adequate cable cross-section outdoors: 1 - 10 m: 1.5 mm²; 10 - 30 m: 2.5 mm²

Always fully unreel the extension cable from the cable drum.

An unsuitable electrical extension cable can be hazardous.

■ SAFE HANDLING

⚠ DANGER:

The user must be the appliance as intended. The person must consider the local conditions and must pay attention to other persons in the vicinity when working with the appliance.

Check important components, such as high pressure hose, hand spray gun and safety installations, for damage prior to every operation. Immediately replace damaged components. Do not operate appliance with damaged components.

The appliance has been designed for use with the cleaning agent supplied or recommended by the manufacturer. The use of the other cleaning agents or chemicals may adversely affect the safety of the appliance.

High-pressure jets can be dangerous if subject to misuse. The jet must not be directed at persons, live electrical equipment or the machine itself. Do not direct the jet against yourself or others in order to clean clothes or foot-wear.

Do not use the appliance within range of persons unless they wear protective clothing.

Wear appropriate Personnel Protection Equipment (PPE) while operating

the appliance.

Do not direct the jet against yourself or others in order to clean clothes or foot-wear.

⚠ WARNING!

The appliance must not be operated by children or untrained personnel. This appliance is not intended for use by persons (including children) with reduced physical, sensory or mental capacities, or lacking experience and knowledge.

Children must not play with this appliance.

If the supply cord is damaged, it must be replaced by the manufacturer, its service agent or similarly qualified persons in order to avoid a hazard.

Supervise children to prevent them from playing with the appliance.

Create stability for the appliance prior to any work on or with the appliance to prevent accidents damage.

The water jet that is emitted from the high-pressure nozzle results in a repulsion power acting on the hand spray gun. Make sure that you have a firm footing and are also holding the hand spray gun and spray lance firmly.

Never leave the appliance unattended as long as it is in operation.

⚠ ATTENTION:

In case of extended breaks, switch the appliance off at the main switch or pull the mains plug.

Do not operate the appliance at temperatures below 0°C

⚠ CAUTION

Don't pull the cord to unplug, when you would like to retract the cable, hold the plug and then press the Turn back button.

Keep off from ovens and stoves, etc.

Don't suck at large fragments or sharp objects.

Don't wrest, tramp and haul the hose.

Keep hair, loose clothing, fingers, and all parts of body away from openings and moving parts.

Do not use to pick up flammable or combustible liquids, such as gasoline,

matches, or use in areas where they may be present.

Do not pick up anything that is burning or smoking, such as cigarettes, matches, or hot ashes.

Do not use without dust bag and/or filters in place.

■ OTHER RISKS

DANGER:

The appliance may not be operating in explosive atmospheres.

Risk of explosion - Do not spray flammable liquids.

Never draw in fluids containing solvents or undiluted acids and solvents!

This includes petrol, paint thinner and heating oil. The spray mist is highly inflammable, explosive and poisonous. Do not use acetone, undiluted acids and solvents, as they corrode the materials used on the appliance.

Never use the product with inflammable or toxic liquids, or liquids with characteristics incompatible with its proper operation.

Keep packaging films away from children, there is a risk of suffocation!

WARNING!

According to applicable regulations, the appliance must never be used on the drinking water net without a system separator. Ensure that the connection of your building water installation on which the high pressure cleaner is operated is equipped with a system separator pursuant

Water that has flown through backflow preventers is considered to be non-potable.

High-pressure hoses, fittings and couplings are important for the safety of the appliance. Only use high-pressure hoses, fittings and couplings recommended by the manufacturer.

To ensure applicable safety, use only original spare parts from the manufacturer or approved by the manufacturer.

Switch the product off and disconnect it from the power supply removing the power plug from the socket outlet before assembly, cleaning, adjustments, maintenance, storage and transportation or converting the product to another function.

⚠ CAUTION:

Mind the weight of the appliance when selecting the storage location and during transport to prevent accidents or injuries.

Several hours of continuous use of the appliance can lead to numbness in the hands in rare cases.

- Wear gloves.
- Keep hands warm.
- Take breaks at regular intervals. Working with detergent

⚠ WARNING!

The improper use of detergents can cause severe injuries or oxidation.

Store cleaning agent away from the reach of children.

Discharge residual pressure before disconnecting the hose from the product.

Check before each use, and at regular intervals, that all metal fasteners are tight and the product's components are in good condition; inspect for broken or worn parts.

Be aware of kick-back: Hold with Both Hands.

■ RESIDUAL RISKS

Even if you are operating this product in accordance with all the safety requirements, potential risks of injury and damage remain. The following dangers can arise in connection with the structure and design of this product:

Health defects resulting from vibration emission if the product is being used over long periods of time or not adequately managed and properly maintained.

Danger of injury and property damage caused by flying objects.

Injuries and damage to property due to broken accessories or the sudden impact of hidden objects during use.

■ SAFETY DEVICES

CAUTION:

Safety installations serve the protection of the user and may not be modified or by past.

■ POWER SWITCH

The appliance switch prevents unintentional operation of the appliance.

■ LOCK TRIGGER GUN

This lock locks the lever of the trigger gun and prevents the inadvertent start of the appliance. Overflow valve with.

Water that has flowed through backflow preventers is considered to be non-potable.

■ PRESSURE SWITCH

If the lever on the trigger gun is released the pressure switch turns off the pump, the high pressure jet is stopped. If the lever is pulled the pump is turned on again.

■ MOTOR PROTECTION SWITCH

The motor protection switch off the device if the power consumption is high.

■ PERSONAL PROTECTIVE EQUIPMENT

CAUTION:

Wear protective clothing and safety goggles to protect against splash back containing water or dirt.

During the use of high-pressure cleaner's aerosols can develop. Inhaling aerosols can cause health damage.

- Depending on the application, completely shielded nozzles (e.g. surface cleaner) that significantly reduce the emission of aqueous aerosols can be used for high-pressure cleaning.

- The use of such shielding is not possible with all applications.

PROPER USE

Use this pressure washer for private households only:

If connection is made to a potable water system, the system shall be protected against backflow.

This high-pressure cleaner is designated with a rated input current. The intended use of this product covers the cleaning of vehicles, buildings, terraces, facades and garden equipment using clean water and biodegradable chemical detergents. Likewise, the product can be used to clean paving slabs or rain gutters.

This product may not be used to clean clothing, shoes and other textiles. The water jet should not be directed against persons. Animals, any electrical equipment or on the product itself. Do not flush any objects which contain health hazardous materials. The product must not be run with inflammable, explosive and toxic liquids.

For safety reasons it is essential to read the entire instruction manual before first operation and to observe all the instructions there in.

ASSEMBLY

Mount loose parts delivered with appliance prior to start-up

1) Installing the handle with screw

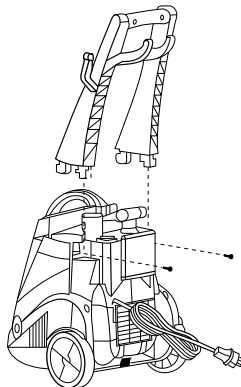

2) Slide the trigger gun hook into position

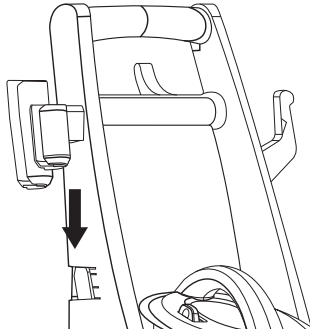

3) Installing the dust compartment into position

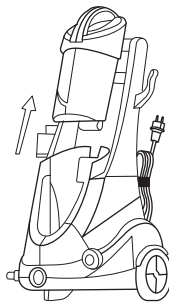

4) Installing the spray wand to trigger gun.

- Fit the spray wand into the gun and rotate it until the two parts are completely locked.

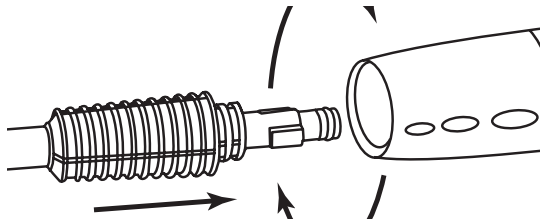

5) Connect the high-pressure hose to the trigger gun

- Connect the sliver end of the high-pressure hose to the trigger gun and

twist the nut as indicated to secure the connection.

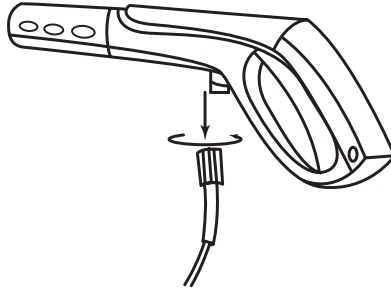

6) Connect the high-pressure hose to the water outlet
Connect the other end of the high-pressure hose to the water outlet on the washer and twist the black rotatable end-piece as indicated to secure the connection.

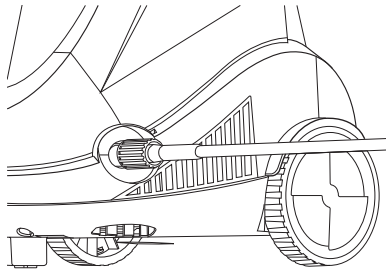

7) Connect the garden hose to the water inlet
Connect the garden hose adaptor(female coupler) to the water inlet of the pressure washer, then thread your garden hose(male end) into the garden hose adaptor.

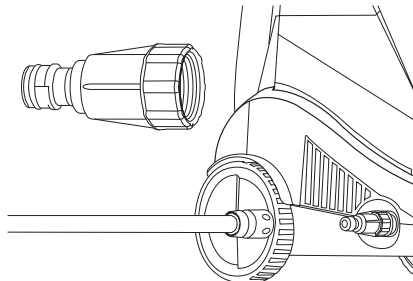

START UP

Park the appliance on an even surface.
Insert the mains plug into the socket.

■ PRESSURE WASHER

ATTENTION:

Impurities in the water can damage the high-pressure pump and the accessories.

Fill the suction hose with water.

Screw the suction hose into the water connection of the appliance and insert it into the water source (e.g. rainwater drum).

Bleed the device as follows prior to operation:

- Turn on the appliance power switch.
- Unlock the lever of the trigger gun.
- Push the lever of the trigger gun, the device will switch on.
- Let the device run (max. 2 minutes) until the water exits the trigger gun without bubbles.
- Release the lever of the trigger gun.
- Lock the lever of the trigger gun.

OPERATION

ATTENTION:

Dry running of more than 2 minutes leads to damage of the high-pressure pump. If the appliance does not build up pressure within 2 minutes, switch the appliance off and proceed in accordance with the instructions in Chapter “Troubleshooting”

■ HIGH PRESSURE WASHER OPERATION

CAUTION:

Keep a distance of at least 30 cm when using the jet for cleaning painted surfaces to avoid damage.

CAUTION

Make sure the on/off switch is set to “OFF” and insert the plug into a properly installed socket.

ATTENTION:

- The washer must be used on a secure and stable surface in a standing, upright position.

Keep a distance of at least 30 cm when using the jet for cleaning painted surfaces to avoid damage.

CAUTION

Make sure the on/off switch is set to “OFF” and insert the plug into a properly installed socket.

ATTENTION:

- The washer must be used on a secure and stable surface in a standing, upright position.

Keep a distance of at least 30 cm when using the jet for cleaning painted surfaces to avoid damage.

CAUTION

Make sure the on/off switch is set to “OFF” and insert the plug into a properly installed socket.

ATTENTION:

- The washer must be used on a secure and stable surface in a standing, upright position.

- Connect the product to power and water supply as described.
 - Open the water supply.
 - Hold the spray gun with both hands.
 - Direct the nozzle of the chosen accessory away from you towards the surface to be cleaned.
 - Unlock the trigger and press it until a constant amount of water flows through the nozzle, to allow air trapped in the hose to escape.
 - Release the trigger.
 - Turn on the switch
 - Hold the spray gun with both hands. Direct the water jet to the object to be cleaned and press the trigger.
- Release the lever of the trigger gun; the device will switch off again and stop the water jet. High pressure remains in the system.

WARNING!

Beware of kickback when pressing the trigger!

■ OPERATION WITH DETERGENT

Detergent can only be added when the device is operated in low pressure mode.

▲ DANGER:

When using detergents, the material data safety sheet issued by the detergent manufacturer must be adhered, especially the instructions regarding personal protective equipment.

Remove the cap of the clean detergent bottle. Gently pull the onboard detergent tank out of its storage position.

Fill the tank with detergent designed specifically for use with pressure washers.

Push the detergent bottle with the opening pointing downwards into the connection for the hose clean detergent.

■ RECOMMENDED CLEANING METHOD

- Spray the detergent sparingly on the dry surface and allow it to react,

but not to dry.

- Spray off loosened dirt with the high pressure Met.



Connect the product to power and water supply as described.

- Open the water supply.
- Hold the spray gun with both hands.
- Direct the nozzle of the chosen accessory away from you towards the surface to be cleaned.
- Unlock the trigger and press it until a constant amount of water flows through the nozzle, to allow air trapped in the hose to escape.
- Release the trigger.
- Turn on the switch
- Hold the spray gun with both hands. Direct the water jet to the object to be cleaned and press the trigger.

Release the lever of the trigger gun; the device will switch off again and stop the water jet. High pressure remains in the system.

⚠ WARNING!

Beware of kickback when pressing the trigger!

■ OPERATION WITH DETERGENT

Detergent can only be added when the device is operated in low pressure mode.

⚠ DANGER:

When using detergents, the material data safety sheet issued by the detergent manufacturer must be adhered, especially the instructions

regarding personal protective equipment.

Remove the cap of the clean detergent bottle. Gently pull the onboard detergent tank out of its storage position.

Fill the tank with detergent designed specifically for use with pressure washers.

Push the detergent bottle with the opening pointing downwards into the connection for the hose clean detergent.

■ **RECOMMENDED CLEANING METHOD**

- Spray the detergent sparingly on the dry surface and allow it to react, but not to dry.
- Spray off loosened dirt with the high pressure Met.

■ **AFTER OPERATION WITH DETERGENT**

- Remove the hose clean detergent bottle from the intake and close it with the lid.
- For storage, put the detergent bottle into the retainer with the cap pointing up.

VACUUM CLEANER OPERATION

⚠ CAUTION:

Make sure the on/off switch is set to “OFF” and insert the plug into a properly installed socket.

Open the air flow block , suck power will come down. If close the block , suck power will max. power.

Turn on the switch “VAC(II)”, then can use it to clean.

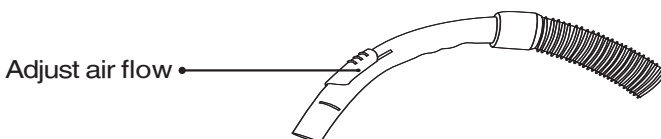

■ INTERRUPTING OPERATION

- Release the lever of the trigger gun.
- Lock the lever of the trigger gun.
- Put the trigger gun with the spray lance into the parking position.
- During longer breaks (more than 5 minutes), also turn the appliance off using the power switch.

■ FINISH OPERATION

- Release the lever of the trigger gun.
 - Turn off the appliance switch pre
 - Disconnect the mains plug from the socket.
- Only separate the high-pressure hose from the trigger gun or the device when there is no pressure in the system.

■ TURN OFF TAP

- Pressure the lever of the trigger gun to release any remaining pressure in the system.
- Release the lever of the trigger gun.
- Lock the lever of the trigger gun.

ATTENTION:

- When disconnecting the supply or high pressure hose, warm water may leak from the connection after operation.
- Detach the appliance from the water supply.

TRANSPORTATION

CAUTION:

Risk of personal injury or damage!
Mind the weight of the appliance during transport.

■ WHEN TRANSPORTING BY HAND

- Switch the product off and disconnect it from the water and power

supply.

- Pull out the transport handle until it audibly snaps into place. Attach transportation guards, if applicable.
- Pull the appliance by its transport handle.

■ WHEN TRANSPORTING IN VEHICLES

- Prior to horizontal transport: close the cap of clean detergent bottle.
- Tilt the product towards you until it balances on the wheels. Then move it by its transportation handle.
- Protect the product from any heavy impact or strong vibrations which may occur during transportation in vehicles.
- Secure the appliance against shifting and tipping over.

STORAGE

CAUTION:

Risk of personal injury or damage!

Consider the weight of the appliance when storing it.

■ STORING THE APPLIANCE

- Park the machine on an even surface.
- Detach spray lance from the trigger gun.
- Push the disconnect button on the trigger gun and pull the high-pressure hose out of the trigger gun.
- Place the trigger gun into the storage for the trigger gun.
- Put both spray lances into the storage for the spray lance.
- Dirt grinder spray lance: Nozzle towards the bottom.
- Coil the high-pressure hose and hang it over the hose storage.
- Store the mains connection in the accessory compartment.
- Prior to extended storage periods, as during the winter, also observe the instructions in the care section.
- Always store the pressure cleaner, parts, and accessories in a place that is inaccessible to children. The ideal storage

temperature is between 10 °C and 30 °C. Store the power washer indoors to prevent the water in the unit from expanding under freezing conditions.

- We recommend using the original package for storage or covering the product with a suitable cloth or enclosure to protect it against dust.

■ FROST PROTECTION

ATTENTION

Appliance and accessories that are not completely drained can be destroyed by frost.

Completely drain appliance and accessories and protect them against frost. To avoid damage:

- Detach the appliance from the water supply.
- Detach spray lance from the trigger gun.
- Turn on the appliance power switch
- Push the lever of the trigger gun until no more water is escaping.
- Release the lever of the trigger gun.
- Lock the lever of the trigger gun.
- Turn off the appliance power switch.
- Store the appliance and the entire accessories in a frost free room.

CARE AND MAINTENANCE

DANGER:

Risk of electric shock

Prior to all work on the appliance, switch off the appliance and pull the power plug.

■ HIGH PRESSURE HOSE

The high pressure hose is specially constructed with reinforced walls it can be easily damaged and should be stored carefully.

- Do not kink.
- Do not drive vehicles over the hose.

- Do not expose the hose to sharp edges or corners. Misuse will lead to ballooning or premature failure and will invalidate warranty.

■ CLEAN THE SIEVE IN THE WATER CONNECTION

Clean the sieve in the water connection regularly.

Remove coupling from the water connection, and rinse with warm water to prevent any foreign matter from clogging the pump.

Clean the nozzle with the needle clean-out tool provided. Remove the spray wand from the gun. Remove any dirt from the nozzle hole and rinse.

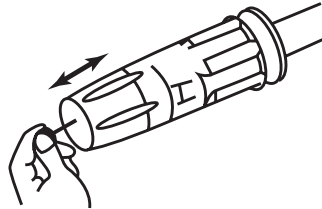

▲ ATTENTION

- The sieve must not be damaged.
- Pull the sieve out using flat pliers.
- Clean the sieve under running water.
- Reinsert the sieve into the water connection.

■ CLEAN THE DUST BAG

pressure the locking block, then push front to open the dust compartment. Take up the dust compartment.

Pressure the automatic release button to empty the dust into dust container.

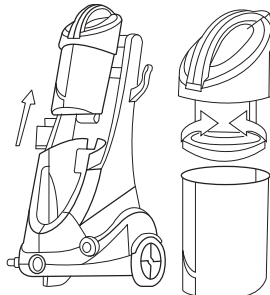

TROUBLESHOOTING

Symptom	Cause	Recommended action
Machine refuses to start	Machine not plugged in Defective socket Fuse has blown Defective extension cord	Plug in machine Try another socket. Replace fuse. Switch off other machines. Try without the extension cord.
Machine stops	Incorrect mains voltage Thermal sensor activated Nozzle partially blocked	Check that the mains voltage corresponds to specification on the model tag. Leave the washer for 5 minutes to cool down. Clean the nozzle
Machine pulsating	Air in inlet hose Inadequate supply of mains water Nozzle partially blocked Water filter blocked Hose kinked	Allow machine to run with open trigger until regular working pressure resumes. Check that the water supply corresponds to specifications required NB! Avoid using long, thin hoses (min. 1/2"). Clean the nozzle /Clean the filter Straighten out hose.
Machine starts, but no water comes out	Pump/hoses or accessory frozen No water supply Water filter blocked / Nozzle blocked	Wait for pump/hoses or accessory to thaw. Connect inlet water. Clean the filter /Clean the nozzle

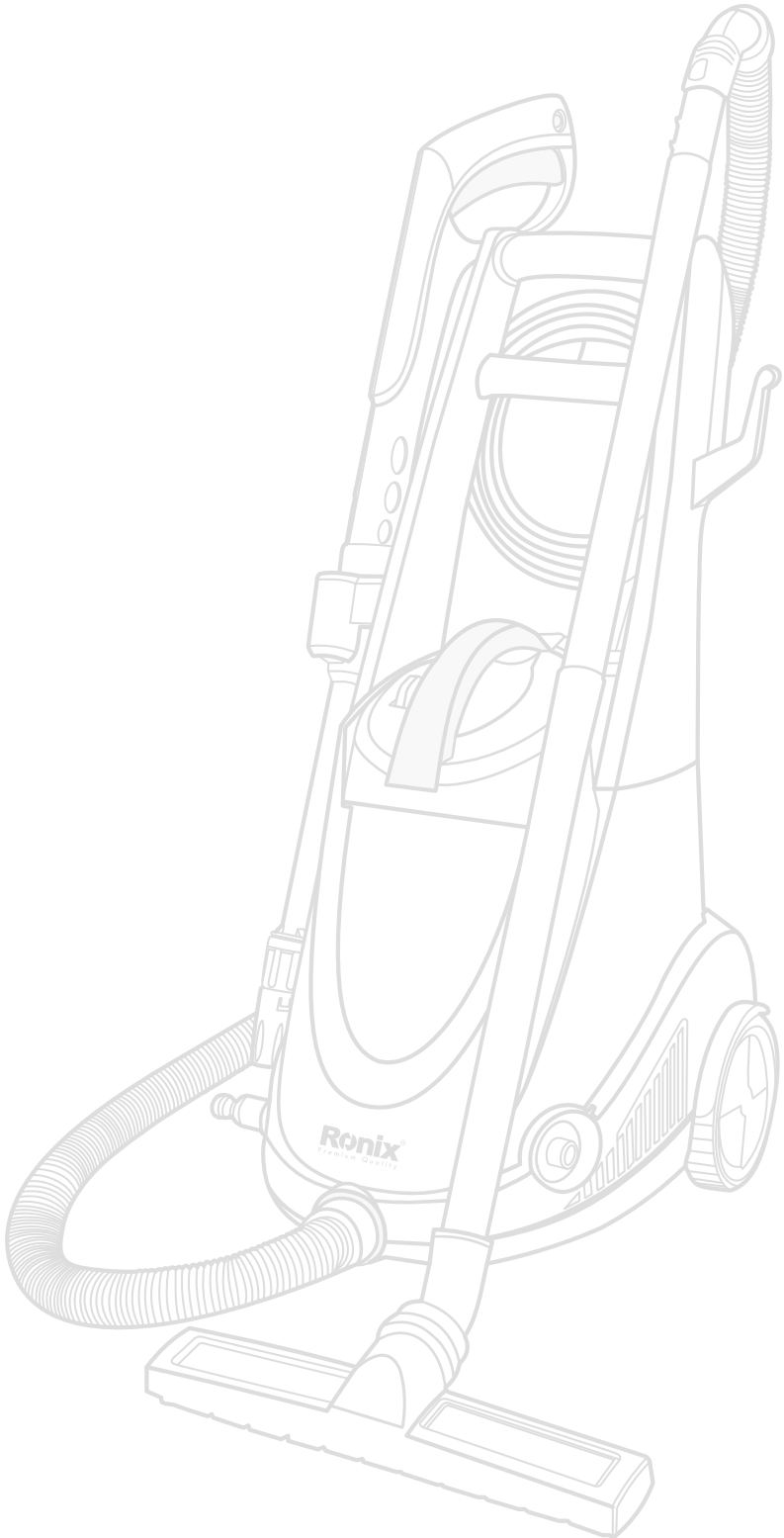

Ronix[®]
Premium Quality

www.ronixtools.com