

Ronix[®]

Premium Quality

HIGH PRESSURE WASHER INDUCTION MOTOR RP-0100C

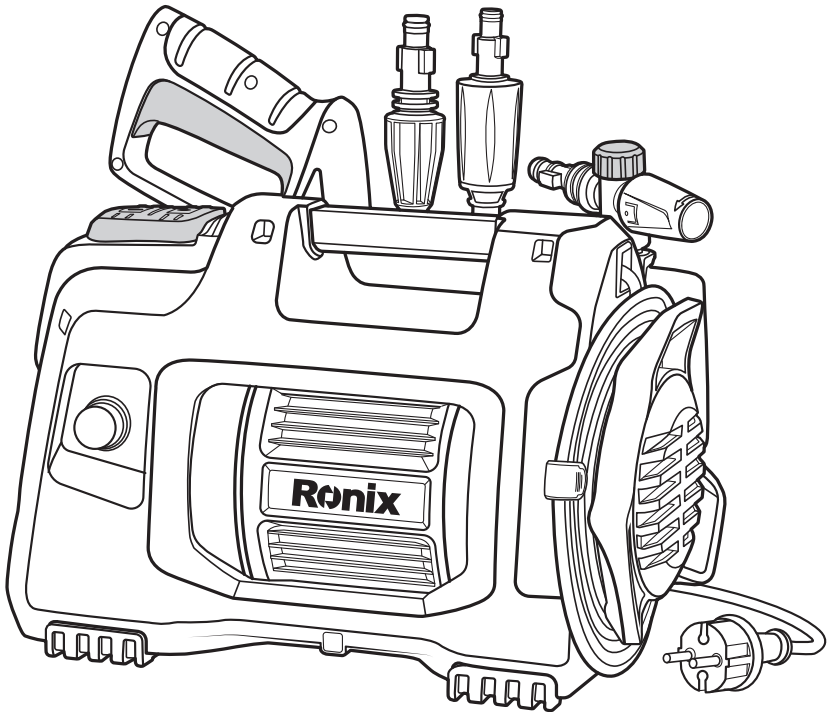

SPECIFICATIONS

Model	RP-0100C
Power	1400W
Voltage	220-240V
Frequency	50-60Hz
Detergent Tank Type	External
Max Rated Flow	6.0L/Min
Weight	10 KG
Dimension	410*290*280mm
Max Pressure	100Bar
Motor Type	Induction
Supplied In	Color box
Includes	Quick connector, Water inlet nut, Adjustable Lances, 5-meter High-pressure PVC hose Detergent Tank, High-pressure Gun

PARTS LIST

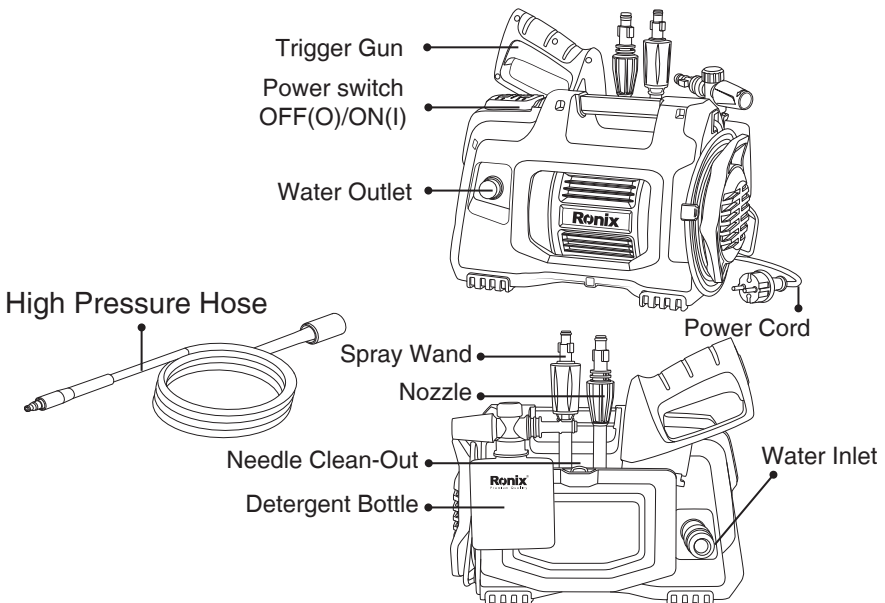

PRODUCT DESCRIPTION

■ PURPOSE

- The high pressure cleaner is designed to clean vehicle, machines, buildings, facades, etc. in the private sector.

■ AREAS OF APPLICATION

- Never use the machine in potentially explosive areas under any circumstances!

- The operating temperature must be between 0 and +40°C

- The machine consists of an assembly with a pump, which is encased in a shock absorbing housing. For an optimal working position the machine come with a lance and a non-slip handle grip, whose shape and configuration comply with the applicable regulations.

- Do not cover or modify the lance or the spray nozzles in any way.

- The high pressure cleaner is designed to be used with cold or lukewarm (max.60); higher temperatures can damage the pump.

- The ideal storage temperature is between 10°C and 30°C but water temperature should be between 0-40°C.

- Do not use water that is dirty, gritty or contains any chemical products, as these could impair operation and shorten the life of the machine.

- Accessories can be used to carry out work with foam cleaners, sand spraying.

IMPORTANT:

This machine is not suitable for connection to the potable water mains.

IMPORTANT SAFETY INSTRUCTIONS

WARNING!

This appliance is not intended for use by children or other persons without assistance or supervision if their physical, sensory or mental capabilities prevent them from using it safely.

Children should be supervised to ensure that they do not play with the appliance. Before starting up your machine please check it carefully for any defects. If you find any, do not start up your machine and contact your distributor.

■ **ESPECIALLY CHECK**

The insulation of the power cord should be faultless and without any cracks. If the power cord is damaged, an authorized distributor should replace it.

WARNING!

- Do not use this appliance without reading this instruction sheets.
- The electric supply connection shall be made by a qualified electrician and comply with IEC60364-1.
- The electric supply to this appliance should include either a residual current device that will interrupt the supply if the leakage current to earth exceeds 30Ma for 30ms or device that will interrupt the earth circuit.

WARNING!

This appliance has been designed for use with the cleaning agent supplied or recommended by the manufacturer. The use of other cleaning agents or chemical may adversely affect the safety of the appliance.

WARNING!

Do not use the appliance within range of person unless they wear protective clothing.

WARNING!

- High pressure jets can be dangerous if subject to misuse. The jet must not be directed at persons, live electrical equipment or the appliance itself.
- Do not direct the jet against yourself or others in order to clean clothes or foot-wear,
- Risk of explosion – do not spray flammable liquids.
- Disconnect from the electrical power supply before carrying out user maintenance.

- High pressure cleaners shall not be used by children or untrained personnel.
- To ensure appliance safety, use only original spare parts from the manufacturer or approved by the manufacturer.

 **WARNING!**

Water that has flown through backflow preventers is considered to be non-potable.

 **WARNING!**

The machine shall be disconnected from its power source during cleaning or maintenance and when replacing parts for mains operated machines by removing the plug from the socket-outlet.

 **WARNING!**

High pressure hoses, fittings and couplings are important for safety of the appliance. Use only hoses, fitting and couplings recommended by the manufacturer.

- Do not use the appliance if a supply cord or important parts of the appliance are damaged, e.g. Safety devices, high pressure hoses, trigger gun.

 **WARNING!**

If an extension cord is used, the plug and socket must be of watertight construction.

 **WARNING!**

Inadequate extension cords can be dangerous.

- This high pressure washer must not be used at temperatures below 0°C.

 **WARNING!**

- Cord on drums should always be completely unwinded to prevent the cord from overheating.
- If an extension cord is used, the plug and socket must be of watertight

construction.

- Inadequate extension cords and be dangerous.
- Comply with the below-mentioned requirements for length and cored dimensions.

1.0mm max. 12.5m

1.5mm max. 20m

2.5mm max. 30m

- Power cord connections should be kept dry and off the ground.
- If the power cord is damaged, it must be replaced by the manufacturer or his service agent or similarly qualified person in order to avoid a hazard.
- All keep the machine on a stable and flat surface during operation, handling, transportation and storage. Sudden overturn of machine will cause injury to body.
- In the event of accident or breakdown, switch off the machine immediately. (e.g. contact with detergent: rinse with an abundance of clean water.)

ATTENTION:

Through poor conditions of the electrical MAINS, shortly voltage drops can appear when starting the EQUIPMENT. this can influence other equipment (e.g. Blinking of a lamp). If the MAINS-IMPEDANCE $Z_{max} < 0.335 \text{ OMH}$, such disturbances are not expected. (in case of need, you may contact your local supply authority for further information.)

WARNING!

ELECTRICAL SHOCK HAZARD

Improper connection of the equipment – grounding conductor can result in a risk of electrical shock. Check with a qualified electrician or service person if you are unsure if an outlet is properly grounded. **DO NOT** modify the plug provided with the appliance to fit an outlet, have a proper outlet installed by a qualified electrician.

■ MAINS POWER CONNECTION

The following should be observed when connecting the high pressure washer to the electric installation:

- The electric installation shall be made by a certified electrician and comply with IEC-60364.

It is recommended that the electric supply to this appliance should include either a residual current device that will interrupt the supply if the leakage current to earth exceeds 30 mA for 30 ms.

▲ **IMPOTANT:**

Only use water without any impurities. If there is a risk of running sands in the inlet water (i.e. from your own well), an additional filter should be mounted.

- Safety devices

- The unloader valve can reduce pressure if it exceeds pre-set values. the spray gun features a locking device. When the pawl is activated, the spray gun cannot be operated.

- Thermal sensor

A thermal sensor protects the motor against overloading. Machine will restart after a few minutes when the thermal sensor has cooled.

ASSEMBLY

- Position the washer as NEAR as possible to the water supply.
- Installing the spray wand

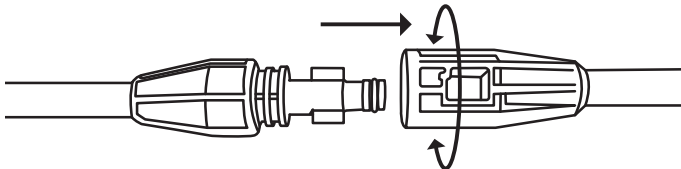

Fit the spray wand into the gun and rotate it until the two parts are completely locked

- Connect the high pressure hose to the trigger gun

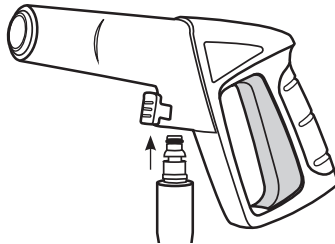

- Connect the sliver end of the high-pressure hose to the trigger gun and twist the nut as indicated to secure the connection.
- Connect the high-pressure hose to the water outlet
- Connect the other end of the high-pressure hose to the water outlet

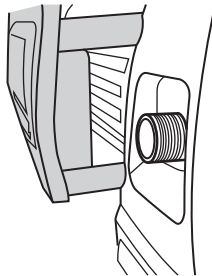

on the washer and twist the black rotatable end-piece as indicated to secure the connection.

- Connect the garden hose to the water inlet
- Connect the garden hose adaptor(female coupler) to the water inlet of

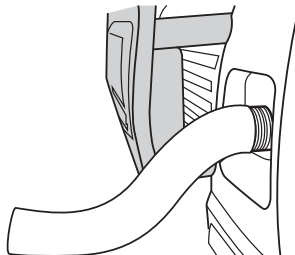

the pressure washer, then thread your garden hose(male end) into the garden hose adaptor.

⚠ NOTE:

The machine not suitable for connection to the potable water main.

⚠ WARNING!

The intake water temperature must not exceed 40. The water supply must not exceed 0.7 MPa.

⚠ CAUTION:

The washer must only be used with clean water; use of unfiltered water of corrosive chemicals will damage the washer.

- Push the motor switch to “OFF” position.

Check the electrical supply voltage and frequency (Volt/Hz) correspond to those specified on the washer rating plate. If the power supply is correct,

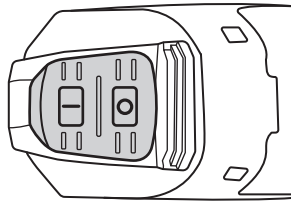

you may now plug in the washer.

OPERATION

- Turn on the water supply tap fully.

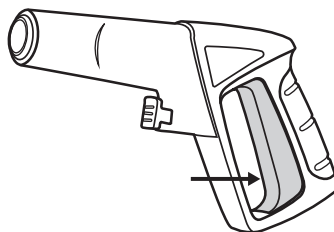

- Release the safety lock then press the trigger for a few seconds

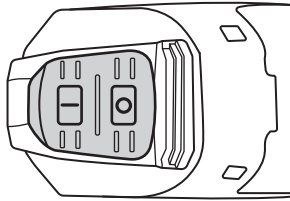

to allow air to escape and discharge residual pressure in the hose.

- Keeping the trigger pressed push the switch to start the motor.
- When re-starting the motor, always keep the trigger pressed.

▲ NOTE:

THE MOTOR ONLY RUNS WHEN THE TRIGGER IS OPERATED.

CORRECT USE OF STANDARD ACCESSORIES



- The washer is equipped with adjustable nozzle.
- Jet adjustment from pencil to fan.

▲ WARNING!

DO NOT ADJUST THE NOZZLE WHILE THE TRIGGER IS SQUEEZED.

RECOMMENDED CLEANING PROCEDURE

- Dissolve dirt by applying detergent with the fan jet to the dry surface. on vertical surfaces, work from the bottom upwards. leave the detergent to act for 1 to 2 minutes, but do not allow to dry out. Apply the high from the surface, working from the bottom upwards.

- Avoid allowing the rinsing water to run on to unwanted surfaces.

STORAGE

- Switch off the washer.
- Turn off the water supply tap.
- After use, the detergent residuals should be removed from the tank.
- Discharge residual pressure by pressing the trigger until no more water comes out of the lance nozzle.
- Engage the gun safety lock.
- Remove the plug from the socket.
- Operate the washer with non-corrosive /non-toxic antifreeze before storing for the winter.

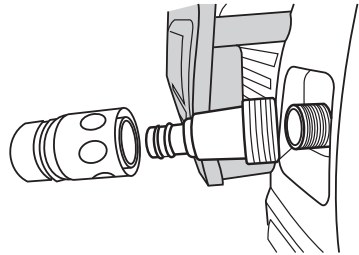
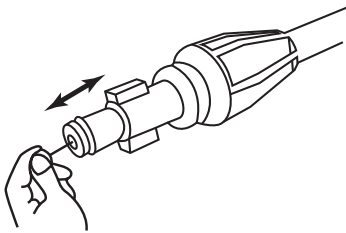

⚠ WARNING!

BEFORE REUSING, COMPLETELY FLUSH THE UNIT OUT WITH PLAIN WATER. ANTI-FREEZE CAN DAMAGE PAINTWORK SO YOU MUST ENSURE THERE IS NO ANTI-FREEZE LEFT IN THE SYSTEM BEFORE USING IT AGAIN.

MAINTENANCE

⚠ CAUTION:

Before working on the washer, disconnect the plug from the power supply socket.

- to ensure good performance. check and clean the suction and detergent

filters after every 50 hours of operation.

- clean the nozzle with tool provided. remove the lance from the gun,

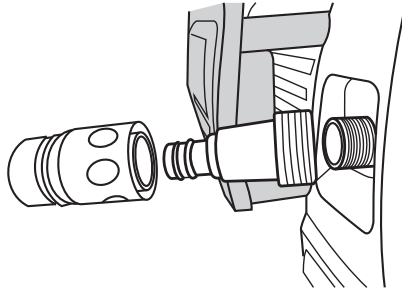

remove any dirt from the nozzle hole and rinse.

TROUBLESHOOTING

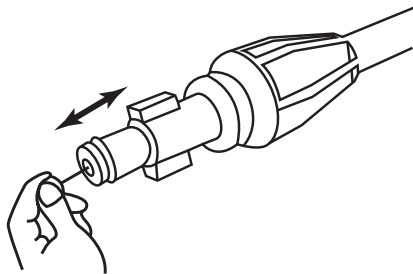

Disconnect from the electrical power supply before carrying out user maintenance or checking is correct functioning. To avoid unnecessary disappointments, you should check the following before contacting the service organization.

In case problems other than the above occur, please contact your local distributor.

Symptom	Cause	Recommended Action
Machine refuses to start	<ul style="list-style-type: none"> - Machine not plugged in - Defective socket - Fuse has blown - Defective extension cord 	<ul style="list-style-type: none"> - Plug in machine - Try another socket - Replace fuse - Switch off other machine - Try without the extension cord
Fluctuating pressure	<ul style="list-style-type: none"> - Pump sucking air - Valve is dirty, worn out or stuck - Pump seals worn out 	<ul style="list-style-type: none"> - Check that hoses and connections are airtight - Clean and replace or refer to local distributor - Clean and replace or refer to local distributor
Machine stops	<ul style="list-style-type: none"> - Fuse has blown - Incorrect mains voltage - Thermal sensor activated - Nozzle partially blocked 	<ul style="list-style-type: none"> - Replace fuse - Switch off other machines - Check that the main voltage corresponds to specification on the model tag - Leave the washer for 5 minutes to cool down - Clean the nozzle
Fuse blows	Fuse too small	<ul style="list-style-type: none"> - Change to an installation higher than the amp consumption of the machine - You may try without the extension cord
Machine pulsating	<ul style="list-style-type: none"> - Air in inlet hose Inadequate supply of mains water - Nozzle partially blocked water filter blocked - Hose kinked 	<ul style="list-style-type: none"> Allow machine to run with open trigger until regular working pressure resumes - Check the water supply corresponds to specifications required - Avoid using long, thin hoses (min. 1/2") - Clean the nozzle - Clean the filter - Straighten out hose
Machine often starts and stops by itself	Pump/spray gun is leaking Centre	Contact your nearest Service Centre
Machine starts, but no water comes out	<ul style="list-style-type: none"> - Pump/hoses or accessory frozen - No water supply - Water filter blocked - Nozzle blocked 	<ul style="list-style-type: none"> - Wait for Pump/hoses or accessory to thaw - Connect inlet water - Clean the filter - Clean the nozzle

Ronix[®]
Premium Quality