

# Ronix<sup>®</sup>

Premium Quality

## AIR COMPRESSOR 50LITER RC-5010

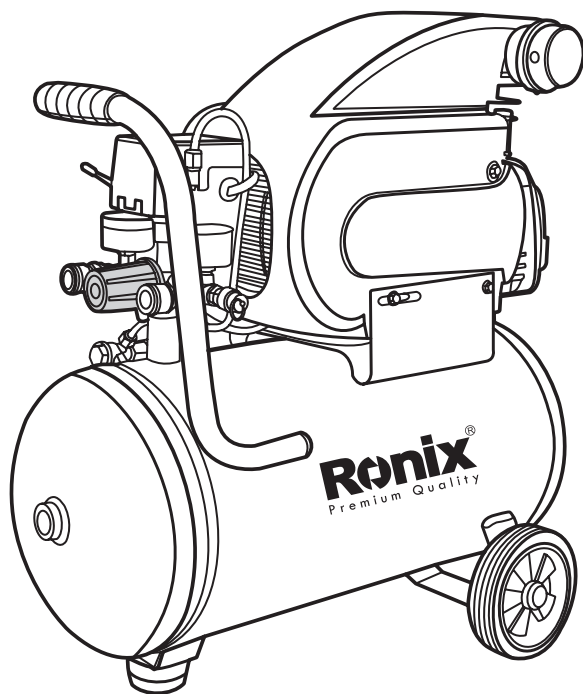



## PARTS LIST

- 1) ON/OFF switch
- 2) Handle
- 3) Safety switch
- 4) Power cord
- 5) Drain valve
- 6) Coupler
- 7) Pressure gauge
- 8) Pressure regulator
- 9) Filter
- 10) Motor housing
- 11) Sight glass
- 12) Oil fill hole

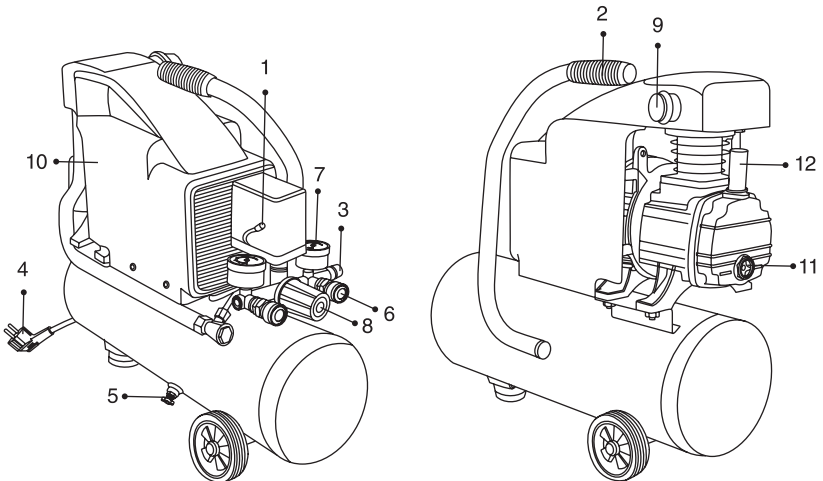

## PRODUCT SPECIFICATIONS

Model	RC-5010
Power	2HP or 1490W
Voltage	220V
Frequency	50Hz
No Load Speed	2800RPM
Air Tank Capacity	50L
Max Pressure	8.0BAR
Air delivery	200L/Min
Net. Weight	30KG

## GENERAL POWER TOOL SAFETY WARNINGS

### **WARNING!**

- Read all safety warnings and all instructions. Failure to follow the warnings and instructions may result in electric shock, fire and or serious injury.
- Save all warnings and instructions for future reference.
- The term “power tool” in the warnings refers to your mains-operated (corded) power tools or battery operated (Cordless) Power tools.

### **■WORK AREA SAFETY**

- Keep work area clean and well lit. Cluttered or dark areas invite accidents.
- Don't operate power tools in explosive atmospheres, such as in the presence of flammable liquids, gases or dust. Power tools create sparks which may ignite the dust or fumes.
- Keep children and bystanders away while operating a power tool. Distractions can cause you to lose control.

## ■ELECTRIC SAFETY

- Power tool plugs must match the outlet. Never modify the plug in any way. Don't use any adaptor plugs with earthed (grounded) power tools. Unmodified plugs and matching outlets will reduce risk of electric shock.
- Avoid body contact with earthed or grounded surfaces such as pipe, radiators, ranges and refrigerators. There is an increased risk of electric shock if your body is earthed or grounded.
- Don't expose power tools to rain or wet conditions. Water entering a power tool will increase the risk of electric shock.
- Don't abuse the cord. Never use the cord for carrying, pulling or unplugging the power tool. Keep cord away from heat, oil, sharp edges or moving parts. Damaged or entangled cords increased the risk of electric shock.
- When operating a power tool outdoors, use an extension cord suitable for outdoor use. Using a cord suitable for outdoor use will reduce the risk of electric shock.
- If operating a power tool in a damp location is unavoidable, use a residual current device (RCD) protected supply. Use of an RCD reduces the risk of electric shock.
- Use of power supply via a RCD with a rated residual current of 30mA or less is always recommended.

## ■PERSONAL SAFETY

- Stay alert, watch what you are doing and use common sense when operating a power tool. Don't use a power tool while you are tired or under the influence of drugs, alcohol or medication. A moment of inattention while operating power tools may result in serious personal injury.
- Use personal protective equipment. Always wear eye protection. Protective equipment such as dust mask, non-skid safety shoes, hard hat, or hearing protection used for appropriate conditions will reduce personal injuries.

- Prevent unintentional starting. Ensure the switch is in the off-position before connecting to power source and/or battery pack, picking up or carrying the tool. Carrying power tools with your finger on the switch or energizing power tools that have the switch on invites accidents.
- Remove any adjusting key or wrench before turning the power tool on. A wrench or a key left attached to a rotating part of the power tool may result in personal injury.
- Don't overreach. Keep proper footing and balance at all times. This enables better control of the power tool in unexpected situations.
- Dress properly. Don't wear loose clothing or jewelry. Keep your hair, clothing, and gloves away from moving parts. Loose cloths, jewelry or long hair can be caught in moving parts.
- If devices are provided for connection of dust extraction and collection facilities, ensure these are connected and properly used. Use of dust collection can reduce dust-related hazards.

## **POWER TOOL USE AND CARE**

- Don't force the power tool. Use the correct power tool for your application. The correct power tool will do the job better and safer at the rate for which it was designed.
- Don't use the power tool if the switch doesn't turn it on and off. Any power tool that cannot be controlled with the switch is dangerous and must be repaired.
- Disconnect the plug from the power source and/or the battery pack from the power tool before making any adjustments, changing accessories, or storing power tools. Such preventive safety measures reduce the risk of starting the power tool accidentally.
- Store idle power tools out of the reach of children and don't allow persons unfamiliar with power tool or these instructions to operate the power tool. Power tools are dangerous in the hands of untrained users.
- Maintain power tools. Check for misalignment or binding of moving parts, breakage o parts and any other condition that

may affect the power tool's operation. If damaged, have the power tool repaired before use. Many accidents are caused by poorly maintained power tools.

- Keep cutting tools sharp and clean. Properly maintained cutting tools with sharp cutting edges are less likely to bind and are easier to control.
- Use the power tool, accessories and tool bits etc. in accordance with the instruction, taking into account the working conditions and the work to be performed. Use of the power tool for operations different from those intended could result in a hazardous situation.

## **SERVICE**

- Have your power tool serviced by qualified repair person using only identical replacement parts. This will ensure that the safety of power tool is maintained.
- Follow instruction for lubricating and changing accessories.
- Keep handles dry, clean and free from oil and grease.

## **AIR COMPRESSOR USE AND CARE**

- Do not exceed the pressure rating of any component in the system.
- Protect material lines and air lines from damage or puncture. Keep hose and power cord away from sharp objects, chemical spills, oil, solvents, and wet floors.
- Check the tank before each use, making certain all connections are secure. Do not use if defect is found.
- Release all pressures within the system slowly. Dust and debris may be harmful.
- Store idle air compressors out of the reach of children and other untrained persons. Air compressors are dangerous in the hands of untrained users.
- Maintain air compressors with care. Follow maintenance instructions. Properly maintained products are easier to control.
- Check for misalignment or binding of moving parts, breakage

of parts, and any other condition that may affect the product's operation. If damaged, have the air compressor serviced before using. Many accidents are caused by poorly maintained products.

- Keep the exterior of the air compressor dry, clean and free from oil and free from oil and grease. Always use a clean cloth when cleaning. Never use brake fluids, gasoline, petroleum- based products, or any strong solvents to clean the unit.
- Following this rule will reduce the risk of deterioration of the enclosure plastic.

## ■ SPECIAL SAFETY RULES

- Know your air compressor. Read operator's manual carefully. Learn its applications and limitations, as well as the specific potential hazards related to this product. Following this rule will reduce the risk of electric shock, fire or serious injury.
- Drain tanks of moisture after each day's use. If unit will not be used for a while, it is best to leave drain valve open unit such time as it to be used. This will allow moisture to completely drain out and help prevent corrosion on the inside of tanks.
- Risk of fire or explosion. Do not spray flammable liquid in a confined area must be well ventilated Do not smoke while spraying or spray where spark or flame is present. Keep compressors as far from the spraying areas as possible, at least 4.5m (15 feet) from the spraying area and all explosive vapors.
- Risk of bursting. Do not adjust regulator to result in output pressure greater than marked maximum pressure of attachment. Do not use at pressure greater than 10 bar.
- If connected to a circuit protected by fuses, use time delay fuses with this product.
- To reduce the risk of electric shock, do not expose to rain. Store indoors.
- Inspect tanks yearly for rust, pin holes, or other imperfections that could cause it to become unsafe.
- Never weld or drill holes in the air tanks.



- Make sure the hose is free of obstructions or sangers.
- Entangled or snarled hoses can cause loss of balance or footing and may become damaged.
- Use the air compressor only for its intended use. Do not alter or modify the unit from the original design or function.
- Always be aware that misuse and improper handling of this product can cause injury to yourself and others.
- Never leave a tool unattended with the air hose attached.
- Never point any air tool toward yourself or others.
- Do not operate this air compressor if it does not contain a legible warning label.
- Do not continue to use a tool or hose that leaks air or does not function properly.
- Always disconnect the air supply and power supply before making adjustments, servicing a product, or when a product is not in use.
- Your tool may require more air consumption than this air compressor is capable providing.
- Always follow all safety rules recommended by the manufacturer of your air tool, in addition to all safety rules for the air compressor. Following this rule will reduce the risk of serious personal injury.
- Never direct a jet of compressed air toward people or animals. Take care not to blow dust and dirt towards yourself or others. Flowing this rule will reduce the risk of serious injury.
- Do not use this air compressor to spray chemicals.
- Your lungs can be necessary in dusty environments or when spraying paint. Do not carry while painting.
- Never use an electrical adaptor with this grounded plug.
- Check damaged parts. Before further use of the air compressor or air tool, a guard or other part that is damaged should be carefully checked to determine that it will operate properly and perform its intended function. Check for alignment of moving parts, binding of moving parts, breakage of parts, mountings and any other conditions that may affect, its operation. A guard or other part that is damaged should be properly repaired or replaced by an authorized service center.

- Following this rule will reduce the risk of shock, fire, or serious injury.
  - Make sure your extension cord is in good condition. When using an extension cord, sure to use one heavy enough to carry the current your product will draw. A wire gauge size (A.W.G) of at least 14 is recommended for an extension cord 7.5 m or less in length. A cord exceeding 15 m is not recommended. If in doubt, use the next heavier gauge. The smaller the gauge number, the heavier the cord. An undersized cord will cause a drop in line voltage resulting in loss of power and overheating.
  - This equipment incorporates parts, such as snap switches, receptacles, and the like that tend to produce arcs or sparks and, therefore, when located in a garage, it should be in a room or enclosure provided for the purpose, or should be 460mm or more above the floor.
  - Never store a tool with air connected. Storing the tool with air connected can result in unexpected firing and possible serious personal injury.
  - Protect your lungs. Wear a face or dust mask if the operation is dusty. Following this rule will reduce the risk of serious personal injury.
  - If the power supply cord is damaged, it must be replaced only by the manufacture or by an authorized service center to avoid risk.
  - Save these instructions. Refer to them frequently and use them to instruct others who may use this product.
  - If you loan someone this product, loan them these instructions also.
  - The machine shall be connected to a circuit protection device (fuse or circuit breaker). The protection device shall be set at 8 A current, and the use shall do necessary test according to clause 18.2.2 of EN 60204-1:2006 to check if the protection device is suitable for use.
  - When the machine is in operation, many parts of machine may cause a high temperature. Use as gloves to avoid injuries resulting from a high temperature.
- This appliance is not intended for use by persons (including

children) with reduced Physical, sensory or mental capabilities, or lack of experience and knowledge, unless they have been given supervision or instruction concerning use of the appliance by a person responsible for their safety. Children should be supervised to ensure that they do not play with the appliance.

## **ASSEMBLY**

### **UNPACKING**

This product requires assembly. Carefully remove the product and any accessories from the box.

#### **⚠ WARNING!**

This product requires assembly. Carefully remove the product and any accessories from the box.

#### **⚠ WARNING!**

Do not use this product if any parts on the packing list are already assembled to your product when you unpack it. Use of a product that may have been improperly assembled could result in serious personal injury.

Inspect the product carefully to make sure no breakage or damage occurred during shipping.

Do not discard the packing material until you have carefully inspected and satisfactorily operated the product.

#### **⚠ WARNING!**

If any parts are damaged or missed, do not operate this product until the parts are replaced. Use of this product with damaged or missing parts could result in serious personal injury.

#### **⚠ WARNING!**

Do not attempt to modify this product or create accessories not recommended for use with this product. Any such alteration or modification is misuse and could result in a hazardous condition

leading to possible serious personal injury.

**⚠ WARNING!**

Do not connect to power supply until assembly is complete. Failure to comply could result in accidental starting and possible serious personal injury.

**■ CHECKING THE OIL**

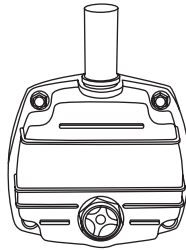

Always check the oil; when the unit is sitting on a level surface and before first use.

- 1) The sight glass is located above the tank. There is a red dot in the center of the glass.
- 2) An oil level at the top of the red dot indicates oil is at maximum level.
- 3) An oil level at or below the bottom of the red dot indicates oil is below desired level, and oil should be added

**TO ADD OIL:**

- 1) Unscrew the cap of oil fill hole.
- 2) Using a funnel, carefully pour oil into the oil fill hole.
- 3) Tighten the cap securely into the oil fill hole.

**⚠ NOTE:**

Avoid too much oil. Ensure that the level of the oil does not exceed the top of red dot at sight glass.

## APPLICATIONS

Air compressors are utilized in a variety of air system applications. Match hoses, connectors, air tools, and accessories to the capabilities of the air compressor.

You may use this product for the purposes listed below:

- Operating some air-powered tools
- Operating air accessories such as air nozzles and tire inflators.

### ■ TO MOVE THE AIR COMPRESSOR

Ensure the air compressor is unplugged, make sure the power cord is secured in the cord wrap.

- 1) Facing the back of the air compressor, grasp the handle firmly with two hands.
- 2) Lift the air compressor toward you until it balances on the wheels.

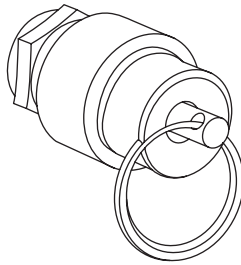

- 3) Push the unit along to the desired location. Lower the air compressor unit so it sits securely on a flat surface.

### ■ BREAK-IN PERIOD

Before first use, run the air compressor at zero tank pressure with the drain valves fully open for 30 minutes.

## •TURNING THE AIR COMPRESSOR ON/OFF

- 1) With the air compressor plugged in, pull the power switch to the ON position to power the compressor on.
- 2) To turn the air compressor off, push the power switch to the OFF position.

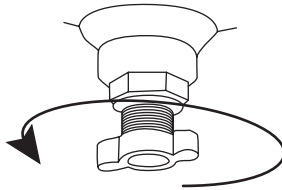

### ⚠ NOTE:

When the compressor is in the ON position, the air compressor will automatically turn back on when the designated tank air pressure limit. It will also shut off again when the desired limit. It will also shut off again when the desired pressure is reached.

### ⚠ WARNING!

Never exceed the air tool's pressure rating as recommended by the manufacturer. When using this air compressor as an inflation device, always follow the maximum inflation guidelines stated by the manufacturer of the item being inflated.

### ⚠ WARNING!

Always ensure the switch is in the OFF (O) position and the regulator pressure gauge reads zero before changing air outlet. Failure to do so could result in possible serious personal injury.

## USING THE AIR COMPRESSOR

- 1) Ensure power switch is in OFF (O) position and air compressor is unplugged.
- 2) If not already installed, attach hose to compressor

- 3) Attach 6.35 mm (1/4 in.) NPT quick- connect air fitting to accessory or tool you intend to use.
- 4) Insert the other end of the quick connect air fitting to the quick coupler on the open end of hose.

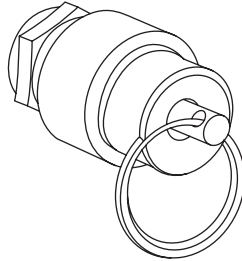

- 5) Connect the power cord to the power supply.
- 6) Turn the switch ON (1).
- 7) Pull out and rotate pressure regulator knob to desired line pressure at the outlet; turning counterclockwise regulator knob to desired line pressure. Turning the knob clockwise increases air pressure at the outlet; turning counterclockwise reduces air pressure at the outlet.
- 8) Following all safety precautions in the air tool manual. You may now proceed to use your air-powered tool.

**⚠ WARNING!**

Air-powered tools may require more air consumption than this air compressor is capable of providing. Check the tool manual to avoid damage to the tool or risk of personal injury.

- 1) Control the amount of air flow with the pressure regulator knob. Turning the knob fully counterclockwise will completely stop the flow of air.

**⚠ NOTE:**

Always use the minimum amount of pressure necessary for your application. Using a higher pressure than needed will drain air from the tank more rapidly and cause the unit to cycle on more frequently.

- 1) When finished, always drain the tank and unplug the unit. Never leave the unit plugged in and/or running unattended.
- 2) Recommended for the use of a residual current device with a rated residual current of 30mA or less.

## **DRAINING THE TANKS**

To help prevent tank corrosion and keep moisture out of the air, used, the air tanks of the compressor should be drained daily.

### **TO DRAIN**

- 1) Turn the air compressor off.
- 2) Pull the ring on the pressure relief valve to release until pressure gauge reads less than 1.4 bar.
- 3) Release the ring.
- 4) Rotate drain valves counterclockwise to open.
- 5) Tilt tank drain moisture tank into a suitable container.

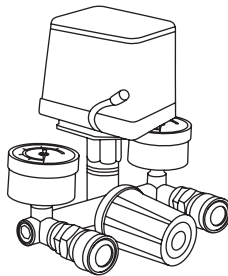

### **⚠ NOTE:**

Condensate is a polluting material and should be disposed of in compliance with local regulations.

- 1) If drain valves are clogged, release all air pressure, remove and clean valves, then reinstall.

### **⚠ DANGER!**

Unplug the air compressor and release all air from the tanks before servicing. Failure to depressurize tanks before attempting



to remove valve cause serious personal injury.  
Rotate drain valves clockwise until tightly closed.

## CHECKING THE SAFETY VALVE

### **WARNING!**

Do not attempt to tamper with the safety valve.  
Anything loosened from this device could fly up and hit you.  
Failure to heed this warning could result death or serious personal injury.

The safety valve will automatically release air if the air tank pressure exceeds the preset maximum. The valve should be checked before each day of use by pulling the ring by hand.

- 1) Turn the air compressor on and allow the tanks to fill. The compressor will shut off when the pressure reaches the preset maximum.
- 2) Turn the air compressor off.
- 3) Pull the ring on the safety valve to release air for three to five seconds.
- 4) The ring pin must be pushed back into position to stop the flow so air at high pressure.

### **WARNING!**

If air leaks after the ring has been released, or if the valve is stuck and cannot be actuated by the ring, do not use the air compressor until the safety valve has been replaced. Use of the air compressor in this condition could result in serious personal injury.

## MAINTENANCE

### **WARNING!**

When servicing use only identical replacement parts.  
Use of any other parts may create a hazard or cause product damage.

**⚠ WARNING!**

Always wear eye protection with side shields. Failure to do so could result in objects being thrown into your eyes resulting in possible serious injury.

**⚠ WARNING!**

Always release all pressure, all pressure, disconnect from power supply, and allow unit to cool to the touch before cleaning or making repairs on the air compressor.

## **GENERAL MAINTENANCE**

Avoid using solvents when cleaning plastic parts. Most plastics are susceptible to damage from various types of commercial solvents and be damaged by their use.

Use clean cloths to remove sort, dust, oil, grease, etc.

AS a routine part of air compressor maintenance, it is also advised that the oil is routinely checked for proper levels.

**⚠ WARNING!**

Do not at any time let brake fluids, gasoline, petroleum- based products, penetrating oils, etc., come in contact with plastic parts, Chemicals can damage, weaken or destroy plastic which may result in serious personal injury.

Electric tools used on fiberglass material, wallboard, speckling compounds, or plaster are subject to accelerated wear and possible premature failure because the fiberglass chips and grindings are highly abrasive to bearings, brushes, commutators, etc. Consequently, we do not recommend using this product for extended work on these types of materials.

However, if you do work with any of these materials, it is extremely important to clean the product using compressed air.

## ■ BEARING LUBRICATION

All of the bearings in this product are lubricated with a sufficient amount of high grade lubricant for the life of the unit under normal operating conditions. Therefore, no further lubrication is required.

## ■ REPLACING THE AIR FILTER

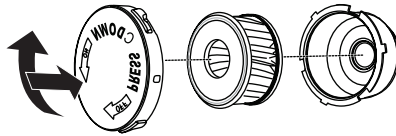

- 1) Turn the air filter cover counterclockwise approximately one-quarter turn.
- 2) Remove the cover
- 3) Remove the air filter.
- 4) Install new air filter.
- 5) Replace the air filter cover and secure it by turning it clockwise.

## ■ CHANGING THE OIL

Replace the oil after the first 10 hours of operation and every 100 hours following the oil change.

The sight glass, located above the tank, indicates the oil level and lets the operator see at a glance if oil should be added.

- 1) Place a suitable container underneath the drain to collect used oil.
- 2) Remove the drain plug with an 8 mm socket or wrench.
- 3) When the used oil has drained, reinstall the drain plug and tighten with the wrench.
- 4) Unscrew the cap of oil fill hole.
- 5) To refill, use a funnel to pour oil into the hole. Refill only with synthetic oil SAE 5W40.

**▲ NOTE:**

Avoid refilling with too much oil. Ensure that the level of the oil does not exceed the top of the red dot at sight glass. The recommended amount of oil for refilling is 250ml.

- 1) Tighten the cap securely into the fill hole.

**■ ENVIRONMENTAL PROTECTION**

Recycle raw materials instead of disposing of as waste. The machine, accessories and packaging should be sorted for environmental-friendly recycling.

**■ TROUBLESHOOTING**

PROBLEM	CAUSE	POSSIBLE SOLUTION
Compressor will not run	Loss of power or overheating	Check for proper use of extension cord
	NO electrical power	Check to be sure unit is plugged in
	Blown shop/house fuse	Check fuse/ breaker
	Shop/house breaker open	Replace shop/house blow fuse
	Current limiting protector open	Reset shop/house breaker, determine why problem happened
	Pressure switch bad	Motor will restart when cool
	Tank is full of air	Compressor will turn on when tank pressure drops to cut-in pressure
Motor hums but cannot run or runs slowly	Low voltage	Check with voltmeter
	Wrong gauge wire or length of extension cord	Check for proper gauge wire and cord length
	Shorted or open motor winding	Take compressor to service center
	Defective check valve or unloader	Take compressor to service center
Current limiting protector Protector cuts out repeatedly	LOW voltage	Check with voltmeter
	Lack of proper ventilation/ room temperature too high	Move compressor to well-ventilated area
	Wrong gauge wire or length of extension cord	Check for proper gauge wire and cord length

Air tank pressure drops when compressor shuts off	Loose connections (fitting , tubing, etc.)	Check all connection with soap and water solution and tighten
	Loose drain valve	Tighten drain valve
	Check valve leaking	Take compressor to service center <b>DANGER</b> Do not disassemble check valve, tank drain valves or safety relief valve with air in tank- bleed tanks.
Excessive moisture in Discharge air	Excessive water in air tanks	Drain tanks
	High humidity	Move to area of less humidity; use air-line filter
Compressor runs continuously	Defective pressure switch	Take compressor to service center
	Excessive air usage	Take compressor to service center
	Piston ring are worn	Decrease air usage; compressor not Large enough for tools requirement
		Replace piston rings; Air intel filter is blocked, call customer service for assistance
Air output lower than normal	Broken inlet valves	Tack compressor to service center
	Connections leaking	Tighten connections