

Ronix®

Premium Quality

2800W GASOLINE GENERATOR

RH-4728

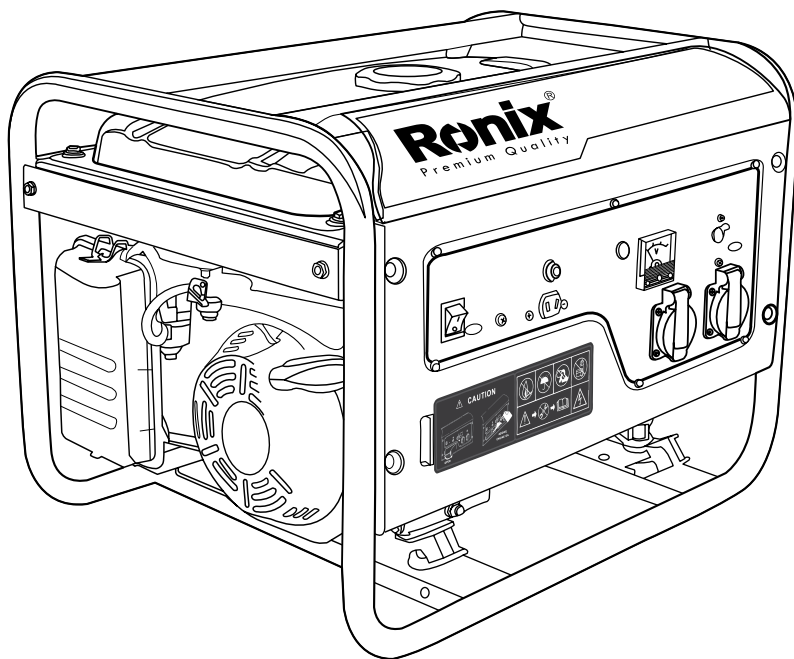

www.ronixtools.com

6
MONTHS
GUARANTY

FREE
DELIVERY

BANK
SPARE PARTS

CALL
CENTER
02161904

TECHNICAL SPECIFICATION

Model	RH-4728
Power	2800W
Voltage	220V
Frequency	50Hz
DC Output	12V-8A
Fuel Capacity	15Liter
Cylinder Capacity	196cc
Noise	<68 DB
Weight	39kg
Full Load Continuous Working	8.6 Hours
1/2 Load Continuous Working	12.9 Hours

PARTS LIST

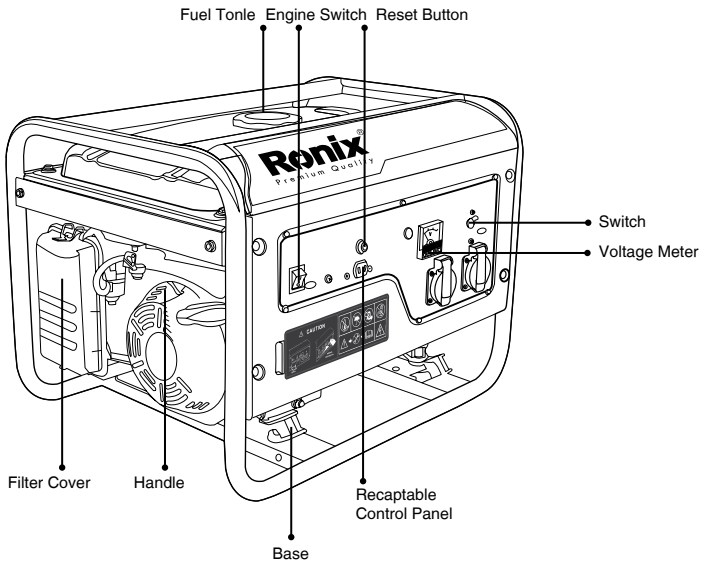

INTENDED USE / NOT INTENDED USE

The machines are portable generators with a four -stroke gasoline engine, with AC 50Hz / 60Hz and 12V DC output for domestic use. The gasoline generator set is suitable for temporary power supply. It may only be operated in a well-ventilated area. The product is intended for household use in accordance with the instructions, all other applications, such as commercial exploitation, are specifically excluded. For damage or injury resulting from an abuse, the user / operator liable and not the manufacturer. Part of the intended use is also the consideration of the safety and operating instructions in the manual. Persons who should operate this machine will be familiar with the instructions and the possible dangers. In addition, the existing safety rules are strictly observed. Other general rules of safety and security areas are respected. Changes to the machines, including the liability of the manufacturer and any damage from this set, the warranty expire. The machine must only be operated outdoors or in a ventilated room.

RESIDUAL RISKS

Even when properly used the machine is always some residual risk that cannot be ruled out. Because of e.g. Use, construction of the machine can be derived during the use if the following potential hazards.

Inhalation of fumes (poisoning danger)

- Avoid contact with hot surfaces / exhaust system (burns)
- Impairment of hearing for non-adherence to the prescribed hearing protection
- Contact with petrol/oil and the skin
- Inhalation of gasoline fumes
- Contact with the coming-promoting medium

SAFETY TIPS

- Never operate the generator in door or in a poor-ventilated area.
- Do not operate the generator under wet climate (rain, snow).
- Never connect to house power circuit if commercial power supply is not cut.
- Keep at least 1 m (3ft) away from inflammables.
- Do not smoking when fueling.
- Do not spilling out when fueling.
- Remember to stop generator before fueling.

OTHER SAFETY TIPS

- Do not touch the muffler or muffler cover while the engine is running or still hot.
- Do not touch the generator when either it or your hand are wet, avoid short circuit or electric shock.
- Never permit anyone to operate the generator without proper instruction.
- Always wear safety shoes and proper cloths.
- Keep children and pets away from the generator when the generator is in operating.

INSPECTION BEFORE OPERATION

•LUBE OIL

Always check the oil level before start the stooping generator on a level place.

- Turn out the oil filter gauge (dipstick) and clean it with a clean cloth.
- Insert the dipstick back without screw in. and check the oil level.
- In the case that the oil level is below the lower mark of the dipstick, refill the oil to the upper mark.
- Reinstall the dipstick.

■ GENERATOR SET ADDING OIL GUIDE

- Access hatch closed

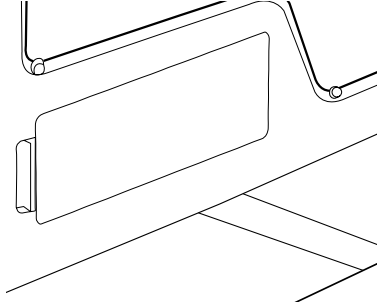

- Unclip the access hatch

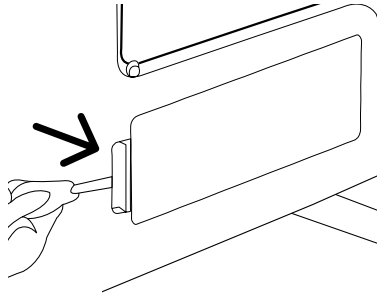

- Open the door

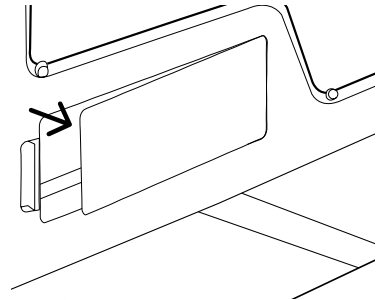

- Remove the hatch

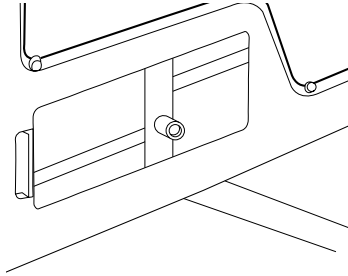

- Release the drain plug

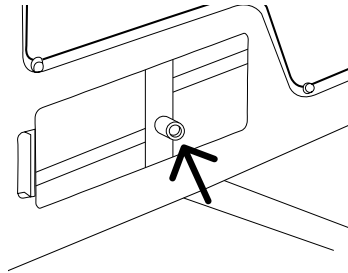

- Add oil through funnel

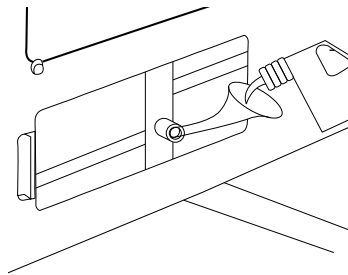

- Tighten the drain plug

- Close the door

• FUEL

- Open the fuel tank cap.

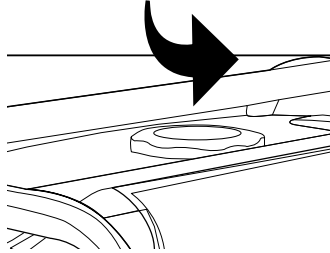

- Check the fuel level and refuel if necessary.

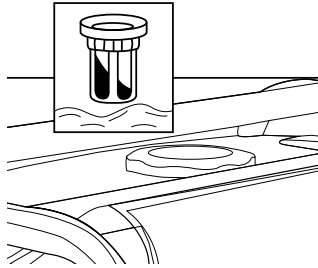

- Refuel up to the shoulder of the fuel filter

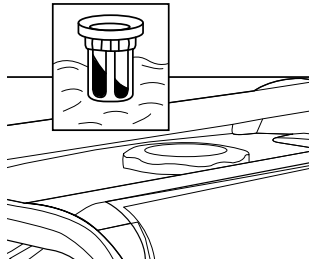

- Reinstall the fuel tank cap.

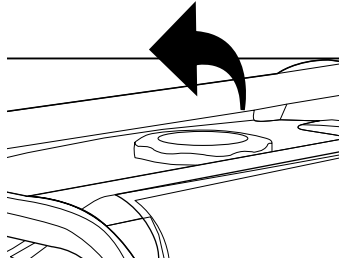

■ AIR CLEANER

- Loosen the clip and remove the air cleaner housing.
- Separate the primary and secondary element.

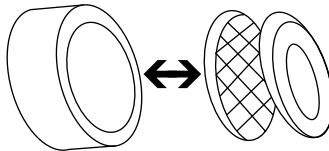

- Wash

■ STARTING THE GENERATOR

- Remove all the loads from AC socket and switch off the BREAKER.

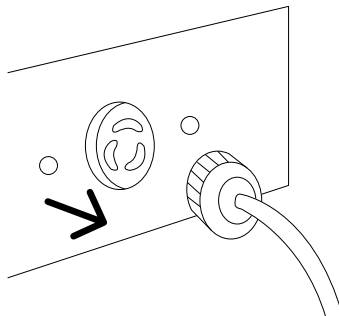

- Set the fuel cock to “ON” position.

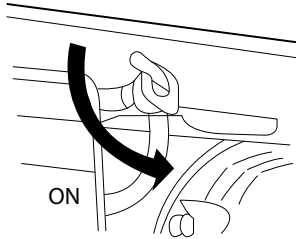

- Push the choke lever to “CLOSE’ position.
- Turn the engine switch to “ON” position.

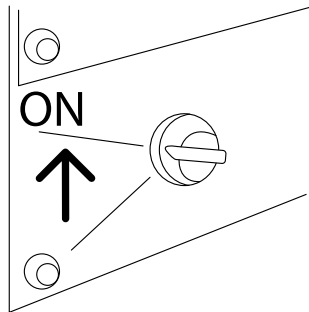

- Pull the starter handle until resistance is felt, then pull it out swiftly from original position.

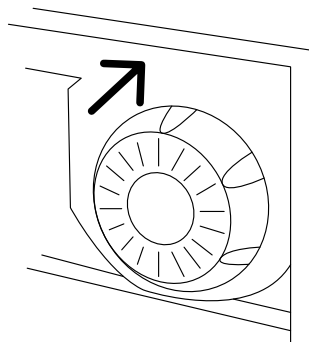

- Once the generator dads, 4-6 gradually turn the chock lever to “ON” position.

ELECTRIC CONNECTING

To keep the generator in the best running and electric condition, please obey the follows:

1. Ground the generator to prevent electric shock:
2. Refer some appliance for electric consumption:

Type	Waltage		Appliance	Sample		
	Rated	Starting		Appliance	Starting	Rated
Electric bulb or heater	X1	X1	Electric bulb TV	Electric bulb 100W	100VA(W)	100VA(W)
Day light lamp	X2	X1.5	Day light lamp	40W Day light lamp	80VA(W)	60VA(W)
Motor drive	X3.5	X2	Refrigerator Electric fan	Refrigerator 150W	450-750 VA	300VA(W)

3.If the generator is supply more than 2 appliances, be sure to start them 5.3 one by one with the highest current first.

CAUTION:

Do not connect the generator to home power circuit. When this connection is necessary, be sure that a skilled electrician does the job. Improper connecting between the generator and home power circuit may cause damage of the generator and even fire accident.

■ AC ELECTRIC CONNECTING

- Starting the generator.

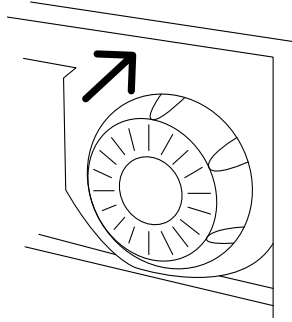

- Connecting the appliances.

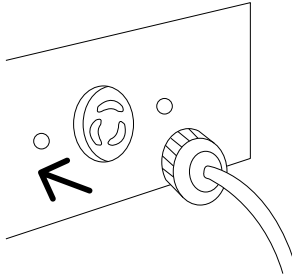

- Turn on the BREAKER or push down the Ac protector.

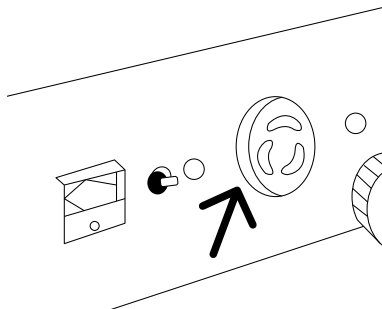

■ DC APPLICATION

The DC terminal may be used for charging 12V automotive-type batteries only.

- When using automotive-type batteries with battery cables, be sure to disconnect the minus pole battery cable from the battery before charging.
- Connect the charging cable to the battery terminals and the DC terminal of generator.
- Connect the positive battery terminal to the positive generator terminal
- Do not reverse the charging cables, or serious damage to the generator and/or Battery may occur.
- Do not allow the free ends of the cable to touch each other, if this occur, it will be short circuit the battery.
- When a large capacity battery is charged, excessive current flows (the value varies depending on the discharged condition) and the fuse for DC current will burn out.
- Batteries produce explosive gases. Keep sparks, flames and cigarettes well away.
- To prevent the possibility of creating a spark near the battery, always connect charging cables to battery first and only then to the generator. When disconnecting, you should disconnect the cables at the generator first.
- Charge the battery in a well-ventilated place.
- Before charging, remove the cap from each cell of the battery. Discontinue charging if the electrolyte temperature exceeds 45°C.

STOPPING THE GENERATOR

1. Turn off the Breaker.

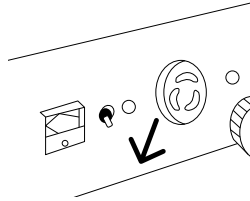

2. Turn off the engine switch.

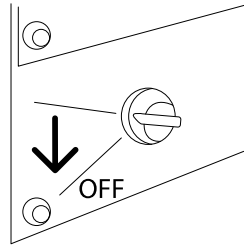

3. Turn off the fuel cock.

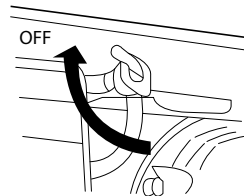

▲ NOTE:

In emergency, turn the engine switch to -OFF to stop the generator.























▲ WARNING!

Never stopping the generator at high speed under heavy load, otherwise, the damage will result.

REGULAR INSPECTION AND MAINTENANCE

Daily and regular inspection is important to assure safe, proper and long-term operation of the generator. Refer to the regular inspection table when conducting inspection and maintenance.

Inspection  Replace  Cleaning  Adjustment 

		Daily check	20hrs or first month	50hrs or every 3 month	100hrs or every 6 month	300hrs or every 1 year
Lube oil check						
Replace engine oil						
Air cleaner check						
Air cleaner wash						
Fuel filter cup						
Fuel filter						
Spark plug						
Value clearance						
Cylinder clearance						
Fuel tank wash		Every 2 years or when necessary 				

ENGINE OIL REPLACEMENT

1. Loosen the of drain plug crankshaft.
2. Drain off the engine oil in the dipstick.
3. Screw in and tighten the drain with seal washer.
4. Filing the engine of to the upper plug level.
5. Reinstall the dipstick

▲ NOTE:

Recommended Engine oil

4-stroke gasoline engine oil SF, SF from API Service Classification or SAE 10W-30 equivalent to SG Class. In Frigid Ambience Temperature (below -15°C) SE.SF from API Service Classification or SAE5W-30 equivalent to SG Class.

SPARK PLUG CLEANING

1. Dismantle the spark plug cap.

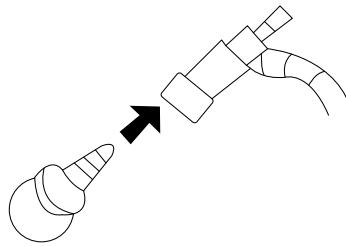

2. Dismantle the spark plug.

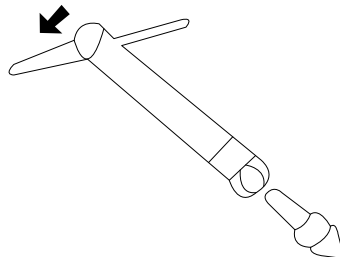

3. Clean away carbon sediment.
4. Measure the electrodes clearance.

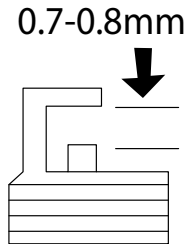

5. Reinstall the spark plug and cap.

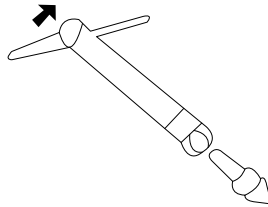

FUEL COCK CLEANING

1. Set the fuel cock to “OFF” position, and dismantle the filter cup. Dismantle the fuel filter.
2. Clean the fuel filter with air blow from inside.
3. Clean the fuel filter cup thoroughly.
4. Mount a new rubber ring and the filter cup securely.

STORAGE OF GENERATOR

If the generator should be stored for a long time (more than 30 days), the following preparation should be made.

1. Loosen the carburetor's drain plug and drain off the fuel in the fuel tank.
2. Loosen the oil drain plug and dipstick, dipstick, drain off the engine oil.
3. Reinstall the drain plug and dipstick.
- 8-4. Pull the starter handle gently until resistance is felt.

TROUBLESHOOTING

1. Starting failure

- Is the engine switch at “ON” position?
- Is the oil level too low?
- Is there enough the fuel?
- Check the spark plug.

2. Appliance do not work

- Check the appliance device.
- Is the BREAKER at “ON” position?

Ronix[®]
Premium Quality

www-ronixtools.com