

# Ronix®

Premium Quality

## BRUSHLESS CIRCULAR SAW

### 8902

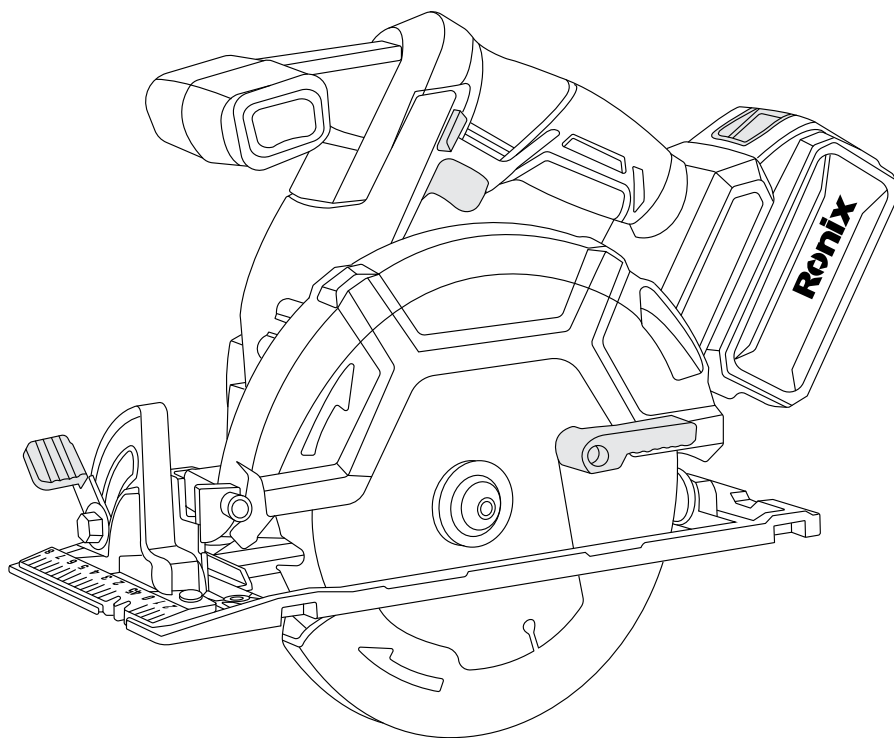

[www.ronixtools.com](http://www.ronixtools.com)

**12**  
MONTHS  
GUARANTY

**FREE**  
DELIVERY

**BANK**  
SPARE PARTS

**CALL**  
CENTER  
02161904



## SPECIFICATION

Model	8902
Voltage	20V
No-load speed	5000 rpm
Blade size	165x20x1.6mm
Max. cut@ 0°	57mm
Max. cut@ 45°	41mm
Max. cut@ 50°	37mm
Bore Diameter	20mm
Weight	2.7KG
Accessories	1pc spanner

**THIS PRODUCT DOES NOT INCLUDE BATTERIES OR CHARGER**

## USABLE BATTERIES FOR 8902

Ronix Model No.	Product
8990	20V battery pack, 2.0Ah Li-ion battery
8991	20V battery pack, 4.0Ah Li-ion battery

## USABLE CHARGERS FOR 8902

Ronix Model No.	Product
8992	20V fast charger, Output:22V 2.2A
8993	20V fast charger, Output:22V 4.5A
8994	20V fast charger, Output:22V 2.2A + 2.2A (Dual Model)

## PART LIST

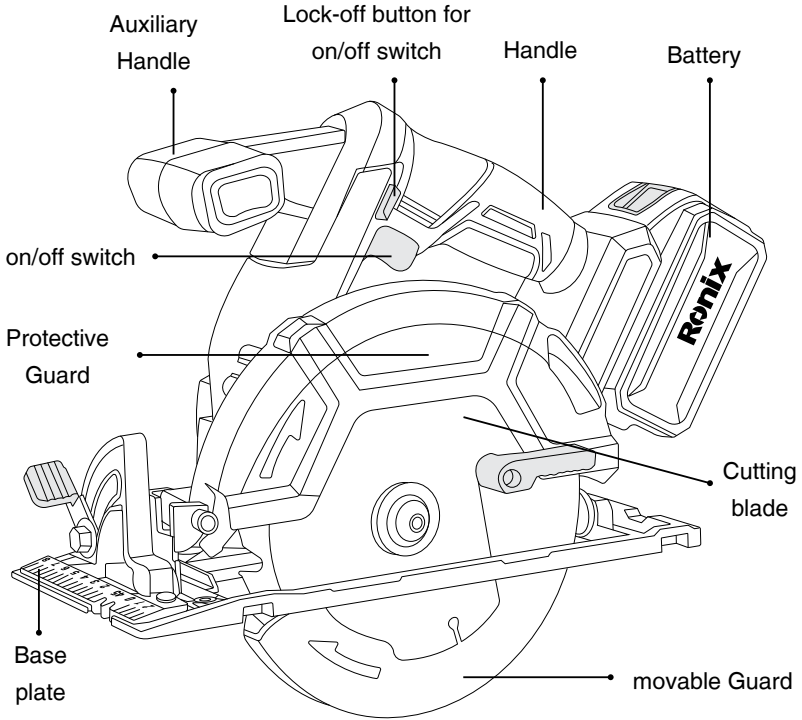

## GENERAL POWER TOOL SAFETY RULES

- Read all safety warnings and all instructions. Failure to follow the warnings and instructions may result in electric shock, fire and/or serious injury.
- Save all warnings and instructions for future reference.
- The term «power tool» in the warnings refers to your mains-operated (corded) power tool or battery-operated (cordless) power tool.

### ■ WORK AREA SAFETY

- Keep work area clean and well lit. Cluttered or dark areas invite accidents.
- Do not operate power tools in explosive atmospheres, such as in the

presence of flammable liquids, gases or dust. Power tools create sparks which may ignite the dust or fumes.

-Keep children and bystanders away while operating a power tool. Distractions can cause you to lose control.

## ■ ELECTRICAL SAFETY

- Power tool plugs must match the outlet. Never modify the plug in any way. Do not use any adapter plugs with earthed (grounded) power tools. Unmodified plugs and matching outlets will reduce risk of electric shock.

- Avoid body contact with earthed or grounded surfaces such as pipes, radiators, ranges and refrigerators. There is an increased risk of electric shock if your body is earthed or grounded.

- Do not expose power tools to rain or wet conditions. Water entering a power tool will increase the risk of electric shock.

- Do not abuse the cord. Never use the cord for carrying, pulling or unplugging the power tool. Keep cord away from heat, oil, sharp edges or moving parts. Damaged or entangled cords increase the risk of electric shock.

- When operating a power tool outdoors, use an extension cord suitable for outdoor use. Use of a cord suitable for outdoor use reduces the risk of electric shock.

- If operating a power tool in a damp location is unavoidable, use a ground fault circuit. Interrupter (GFCI) protected supply. Use of a GFCI reduces the risk of electric shock.

## ■ PERSONAL SAFETY

- Stay alert, watch what you are doing and use common sense when operating a power tool. Do not use a power tool while you are tired or under the influence of drugs, alcohol or medication. A moment of inattention while operating power tools may result in serious personal injury.

- Use personal protective equipment. Always wear eye protection. Protective equipment such as dust mask, non-skid safety shoes, hard hat, or hearing protection used for appropriate conditions will

reduce personal injuries.

- Prevent unintentional starting. Ensure the switch is in the off-position before connecting to power source and/ or battery pack, picking up or carrying the tool. Carrying power tools with your finger on the switch or energizing power tools that have the switch on invites accidents.
- Remove any adjusting key or wrench before turning the power tool on. A wrench or a key left attached to a rotating part of the power tool may result in personal injury.
- Do not overreach. Keep proper footing and balance at all times. This enables better control of the power tool in unexpected situations.
- Dress properly. Do not wear loose clothing or jewelry. Keep your hair, clothing, and gloves away from moving parts. Loose clothes, jewelry or long hair can be caught in moving parts.
- If devices are provided for the connection of dust extraction and collection facilities, ensure these are connected and properly used. Use of dust collection can reduce dust-related hazards.

#### ■ **POWER TOOL USE AND CARE**

- Do not force the power tool. Use the correct power tool for your application. The correct power tool will do the job better and safer at the rate for which it was designed.
- Do not use the power tool if the switch does not turn it on and off. Any power tool that cannot be controlled with the switch is dangerous and must be repaired.
- Disconnect the plug from the power source and/or the battery pack from the power tool before making any adjustments, changing accessories, or storing power tools. Such preventive safety measures reduce the risk of starting the power tool accidentally.
- Store idle power tools out of the reach of children and do not allow persons unfamiliar with the power tool or these instructions to operate the power tool. Power tools are dangerous in the hands of untrained users.
- Maintain power tools. Check for misalignment or binding of moving

## ■ SERVICE

- Have your power tool serviced by a qualified repair person using only identical replacement parts. This will ensure that the safety of the power tool is maintained.
- Follow instruction for lubricating and changing accessories.
- Keep handles dry, clean and free from oil and grease.

## CORDLESS CIRCULAR SAW SAFETY WARNINGS

### ■ CUTTING PROCEDURES

- 1) **DANGER:** Keep hands away from cutting area and the blade. Keep your second hand on auxiliary handle, or motor housing. If both hands are holding the saw, they cannot be cut by the blade.
- 2) Do not reach underneath the workpiece. The guard cannot protect you from the blade below the workpiece.
3. Adjust the cutting depth to the thickness of the workpiece. Less than a full tooth of the blade teeth should be visible below the workpiece.
- 4) Never hold piece being cut in your hands or across your leg. Secure the workpiece to a stable platform. It is important to support the work properly to minimize body exposure, blade binding, or loss of control.

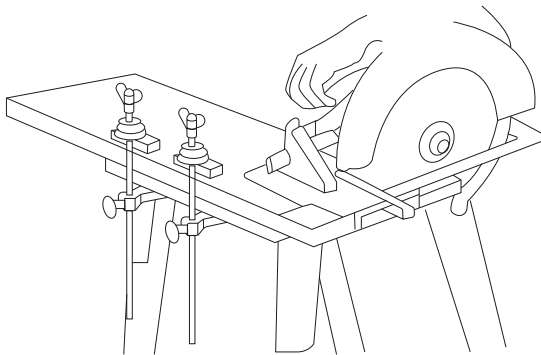

parts, breakage of parts and any other condition that may affect the power tool's operation. If damaged, have the power tool repaired before

use. Many accidents are caused by poorly maintained power tools.

- Keep cutting tools sharp and clean. Properly maintained cutting tools with sharp cutting edges are less likely to bind and are easier to control.
- Use the power tool, accessories and tool bits etc. in accordance with these instructions, taking into account the working conditions and the work to be performed. Use of the power tool for operations different from those intended could result in a hazardous situation.

#### ■ BATTERY TOOL USE AND CARE

- Recharge only with the charger specified by the manufacturer. A charger that is suitable for one type of battery pack may create a risk of fire when used with another battery pack.
  - Use power tools only with specifically designated battery packs. Use of any other battery packs may create a risk of injury and fire.
  - When battery pack is not in use, keep it away from other metal objects, like paper clips, coins, keys, nails, screws or other small metal objects that can make a connection from one terminal to another. Shorting the battery terminals together may cause burns or a fire.
  - Under abusive conditions, liquid may be ejected from the battery; avoid contact. If contact accidentally occurs, flush with water. If liquid contacts eyes, additionally seek medical help. Liquid ejected from the battery may cause irritation or burns.
- 5) Hold the power tool by insulated gripping surfaces only, when performing an operation where the cutting tool may contact hidden wiring. Contact with a “live” wire will also make exposed metal parts of the power tool “live” and could give the operator an electric shock.
  - 6) When ripping, always use a rip fence or straight edge guide. This improves the accuracy of cut and reduces the chance of blade binding.
  - 7) Always use blades with correct size and shape (diamond versus round) of arbor holes. Blades that do not match the mounting hardware of the saw will run eccentrically, causing loss of control.
  - 8) Never use damaged or incorrect blade washers or bolt. The blade and washers and bolt were specially designed for your saw, for optimum



performance and safety of operation.

## **KICKBACK CAUSES AND RELATED WARNINGS**

– kickback is a sudden reaction to a pinched, bound or misaligned saw blade, causing an uncontrolled saw to lift up and out of the workpiece toward the operator.

– when the blade is pinched or bound tightly by the kerf closing down, the blade stalls and the motor reaction drives the unit rapidly back toward the operator.

– if the blade becomes twisted or misaligned in the cut, the teeth at the back edge of the blade can dig into the top surface of the wood causing the blade to climb out of the kerf and jump back toward the operator.

Kickback is the result of saw misuse and/or incorrect operating procedures or conditions and can be avoided by taking proper precautions as given below.

9) Maintain a firm grip with both hands on the saw and position your arms to resist kickback forces. Position your body to either side of the blade, but not in line with the blade.

Kickback could cause the saw to jump backwards, but kickback forces can be controlled by the operator, if proper precautions are taken.

10) When blade is binding, or when interrupting a cut for any reason, release the trigger and hold the saw motionless in the material until the blade comes to a complete stop. Never attempt to remove the saw from

11) When restarting a saw in the workpiece, center the saw blade in the kerf and check that saw teeth are not engaged into the material. If saw blade is binding, it may walk up or kickback from the workpiece as the saw is restarted.

12) Support large panels to minimize the risk of blade pinching and kickback. Large panels tend to sag under their own weight. Supports must be placed under the panel on both sides, near the line of cut and near the edge of the panel.

13) Do not use dull or damaged blades. Unsharpened or improperly set

blades produce narrow kerf causing excessive friction, blade binding and kickback.

14) Blade depth and bevel adjusting locking levers must be tight and secure before making cut. If blade adjustment shifts while cutting, it may

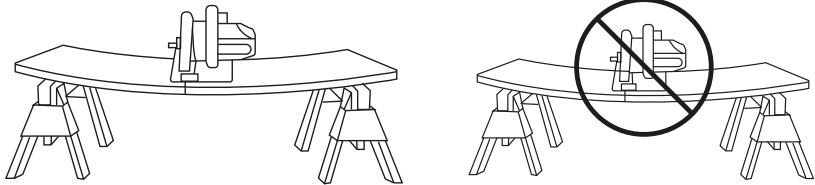

cause binding and kickback.

15) Use extra caution when sawing into existing walls or other blind areas. The protruding blade may cut objects that can cause kickback.

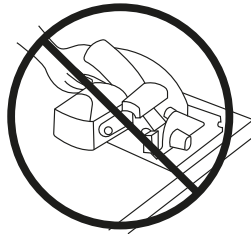

16) ALWAYS hold the tool firmly with both hands. NEVER place your hand or fingers behind the saw. If kickback occurs, the saw could easily jump backwards over your hand, leading to serious personal injury.

17) Never force the saw. Push the saw forward at a speed so that the blade cuts without slowing. Forcing the saw can cause uneven cuts, loss of accuracy, and possible kickback.

## ■ LOWER GUARD FUNCTION

18) Check lower guard for proper closing before each use. Do not operate the saw if lower guard does not move freely and close instantly. Never clamp or tie the lower guard into the open position. If saw is accidentally dropped, lower guard may be bent. Raise the lower guard with the retracting handle and make sure it moves freely and does not touch the blade or any other part, in all angles

and depths of cut.

19) Check the operation of the lower guard spring. If the guard and the spring are not operating properly, they must be serviced before use. Lower guard may operate sluggishly due to damaged parts, gummy deposits, or a build-up of debris.

20) Lower guard should be retracted manually only for special cuts such as “plunge cuts” and “compound cuts”. Raise lower guard by retracting handle and as soon as blade enters the material, the lower guard must be released. For all other sawing, the lower guard should operate automatically.

21) Always observe that the lower guard is covering the blade before placing saw down on bench or floor. An unprotected, coasting blade will cause the saw to walk backwards, cutting whatever is in its path. Be aware of the time it takes for the blade to stop after switch is released.

22) To check lower guard, open lower guard by hand, then release and watch guard closure. Also check to see that retracting handle does not touch tool housing. Leaving blade exposed is **VERY DANGEROUS** and can lead to serious personal injury.

Additional safety warnings

23) Intended use This tool is intended to cut wood products only. Accumulated sawdust on the lower guard and hub from other materials may affect the proper closure of the lower guard which could lead to serious personal injury.

24) Use extra caution when cutting damp wood, pressure treated lumber, or wood containing knots. Maintain smooth advancement of tool without decrease in blade speed to avoid overheating the blade tips.

25) Do not attempt to remove cut material when blade is moving. Wait until blade stops before grasping cut material. Blades coast after turn off.

26) Avoid Cutting Nails. Inspect for and remove all nails from lumber before cutting.

27) Place the wider portion of the saw base on that part of the workpiece which is solidly supported, not on the section that will fall off when the cut is made. As examples, Fig. 1 illustrates the **RIGHT** way to cut off the end of a board, and Fig. 2 the **WRONG** way. If the workpiece is short or small, clamp it down.

## DO NOT TRY TO HOLD SHORT PIECES BY HAND!

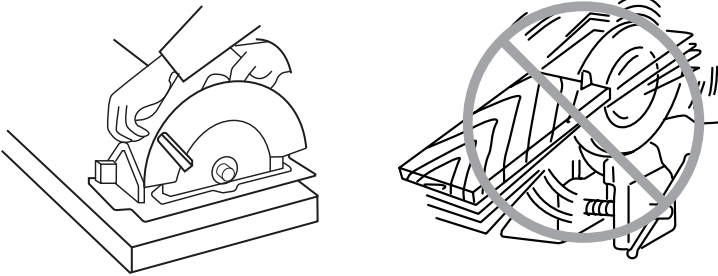

28) Before setting the tool down after completing a cut, be sure that the lower guard has closed and the blade has come to a complete stop.

29) Never attempt to saw with the circular saw held upside down in a vise. This is extremely dangerous and can lead to serious accidents.

30) Some material contains chemicals which may be toxic. Take caution to

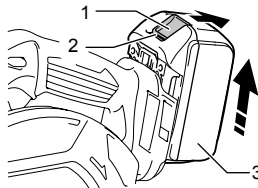

prevent dust inhalation and skin contact. Follow material supplier safety data.

31) Do not stop the blades by lateral pressure on the saw blade.

32) Do not use any abrasive wheels.

33) Only use the saw blade with the diameter that is marked on the tool or specified in the manual.

Use of an incorrectly sized blade may affect the proper guarding of the blade or guard operation which could result in serious personal injury.

34) Keep blade sharp and clean. Gum and wood pitch hardened on blades

slows saw and increases potential for kickback. Keep blade clean by first removing it from tool, then cleaning it with gum and pitch remover, hot water or kerosene. Never use gasoline.

35) Wear a dust mask and hearing protection when use the tool.

## **SAVE THESE INSTRUCTIONS**

### **⚠ WARNING!**

DO NOT let comfort or familiarity with product (gained from repeated use) replace strict adherence to safety rules for the subject product. MISUSE or failure to follow the safety rules stated in this instruction manual may cause serious personal injury.

## **SYMBOLS**

The followings show the symbols used for tool.

volts

direct current

no load speed

revolutions or reciprocation per minute

## **IMPORTANT SAFETYINSTRUCTIONS FOR BATTERY CARTRIDGE**

- 1) Before using battery cartridge, read all instructions and cautionary markings on (1) battery charger, (2) battery, and (3) product using battery.
- 2) Do not disassemble battery cartridge.
3. If operating time has become excessively shorter, stop operating immediately. It may result in a risk of overheating, possible burns and even an explosion.
- 4) If electrolyte gets into your eyes, rinse them out with clear water and seek medical attention right away. It may result in loss of your eyesight.

5) Do not short the battery cartridge:

(1) Do not touch the terminals with any conductive material.

(2) Avoid storing battery cartridge in a container with other metal objects such as nails, coins, etc.

(3) Do not expose battery cartridge to water or rain. A battery short can cause a large current flow, overheating, possible burns and even a breakdown.

6) Do not store the tool and battery cartridge in locations where the temperature may reach or exceed 50°C (122°F).

7) Do not incinerate the battery cartridge even if it is severely damaged or is completely worn out. The battery cartridge can explode in a fire.

8) Be careful not to drop or strike battery.

9) Do not use a damaged battery.

10) Follow your local regulations relating to disposal of battery.

## **SAVE THESE INSTRUCTIONS**

### **CAUTION:**

Only use genuine RONIX batteries. Use of non-genuine RONIX batteries, or batteries that have been altered, may result in the battery bursting causing fires, personal injury and damage. It will also void the RONIX warranty for the RONIX tool and charger.

Tips for maintaining maximum battery life

1) Charge the battery cartridge before completely discharged. Always stop tool operation and charge the battery cartridge when you notice less tool power.

2) Never recharge a fully charged battery cartridge.

Overcharging shortens the battery service life.

3) Charge the battery cartridge with room temperature at 10°C - 40°C (50°F - 104°F). Let a hot battery cartridge cool down before charging it.

4) Charge the battery cartridge if you do not use it for a long period (more than six months).

## FUNCTIONAL DESCRIPTION

### **⚠ CAUTION:**

Always be sure that the tool is switched off and the battery cartridge is removed before adjusting or checking function on the tool. Installing or removing battery cartridge.

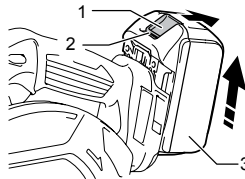

### **⚠ CAUTION:**

Always switch off the tool before installing or removing of the battery cartridge. Hold the tool and the battery cartridge firmly when installing or removing battery cartridge. Failure to hold the tool and the battery cartridge firmly may cause them to slip off your hands and result in damage to the tool and battery cartridge and a personal injury. To remove the battery cartridge, slide it from the tool while sliding the button on the front of the cartridge.

To install the battery cartridge, align the tongue on the battery cartridge with the groove in the housing and slip it into place. Insert it all the way until it locks in place with a little click. If you can see the red indicator on the upper side of the button, it is not locked completely.

### **⚠ CAUTION:**

Always install the battery cartridge fully until the red indicator cannot be seen. If not, it may accidentally fall out of the tool, causing injury to you or someone around you.

Do not install the battery cartridge forcibly. If the cartridge does not slide in easily, it is not being inserted correctly.

**⚠ NOTE:**

When the battery cartridge is not removed easily, push it from the opposite side of the button and slide it.

**INDICATING THE REMAINING BATTERY CAPACITY**

Press the check button on the battery cartridge to indicate the remaining

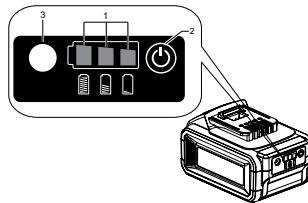

battery capacity. The indicator lamps light up for a few seconds.

Indicator lamps		Remaining capacity
Lighted	Off	
■ ■ ■	□ □ □	75% to 100%
■ ■ □	□ □ □	35% to 75%
■ □ □	□ □ □	5% to 35%

**⚠ CAUTION:**

Before installing the battery cartridge into the tool, always check to see that the switch trigger actuates properly and returns to the “OFF”

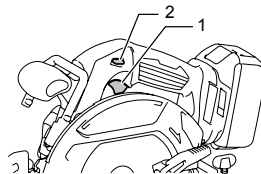

position when released.

Do not pull the switch trigger hard without pressing the lock-off lever. This can cause switch breakage.



To prevent the switch trigger from being accidentally pulled, a lock-off lever is provided. To start the tool, press the lock-off lever and pull the switch trigger. Release the switch trigger to stop.

**⚠ WARNING!**

For your safety, this tool is equipped with lock-off lever which prevents the tool from unintended starting. NEVER use the tool if it runs when you simply pull the switch trigger without pressing the lock-off lever.

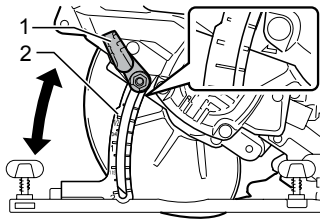

NEVER tape down or defeat purpose and function of lock-off lever.

**⚠ CAUTION:**

After adjusting the depth of cut, always tighten the lever securely. Loosen the lever on the side of the rear handle and move the base up or down. At the desired depth of cut, secure the base by tightening the lever.

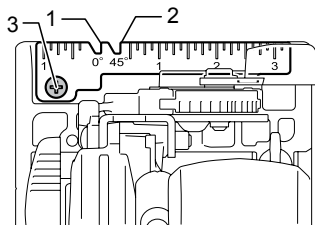

For cleaner, safer cuts, set cut depth so that no more than one blade tooth projects below workpiece. Using proper cut depth helps to reduce potential for dangerous KICKBACKS which can cause personal injury.

For straight cuts, align the 0° position on the front of the base with your cutting line. For 45° bevel cuts, align the 45° position with it. The position of the top guide is adjustable.

**⚠ CAUTION:**

Do not look in the lamp or see the source of lamp directly.

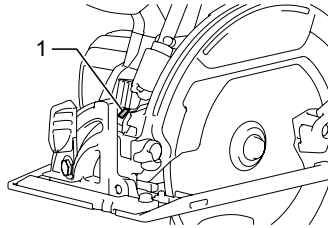

Only to turn on the lamp, pull the switch trigger without pressing the lock-off lever. To turn on the lamp and run the tool, press the lock-off lever and pull the switch trigger with pressing the lock-off lever. The lamp keeps on lighting while the switch trigger is being pulled. The lamp goes out 10 -15 seconds after releasing the trigger.

**⚠ NOTE:**

Use a dry cloth to wipe the dirt off the lens of lamp. Be careful not to scratch the lens of lamp, or it may lower the illumination.

Do not use gasoline, thinner or the like to clean the lens of lamp. Using such substances will damage the lens.

## ASSEMBLY

**⚠ CAUTION:**

Always be sure that the tool is switched off and the battery cartridge is removed before carrying out any work on the tool.

Removing or installing saw blade.

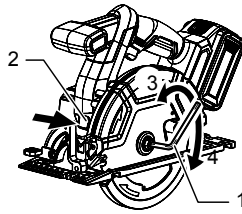

**⚠ CAUTION:**

Be sure the blade is installed with teeth pointing up at the front of the tool. Use only the RONIX wrench to install or remove the blade.

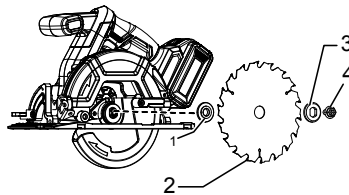

To remove the blade, press the shaft lock so that the blade cannot revolve and use the wrench to loosen the hex bolt clockwise. Then remove the hex bolt, outer flange and blade.

To install the blade, follow the removal procedure in reverse. **BE SURE TO TIGHTEN THE HEX BOLT COUNTERCLOCKWISE SECURELY.**

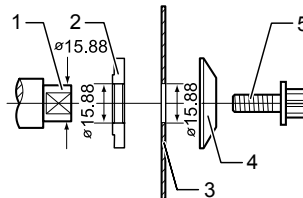

When changing blade, make sure to also clean the upper and lower blade guards of accumulated sawdust as discussed in the Maintenance section. Such efforts do not replace the need to check lower guard operation before each use.

Mount the inner flange with its recessed side facing outward onto the mounting shaft and then place saw blade, outer flange and hex bolt.  
**BE SURE TO TIGHTEN THE HEX BOLT COUNTERCLOCKWISE SECURELY.**

**⚠ CAUTION:**

Be sure to move the tool forward in a straight line gently. Forcing or

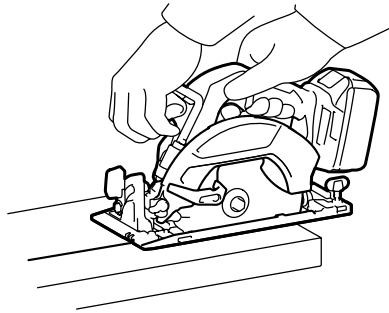

twisting the tool will result in overheating the motor and dangerous kickback, possibly causing severe injury.

Always use a front grip and rear handle and firmly hold the tool by both front grip and rear handle during operations.

Hold the tool firmly. The tool is provided with both a front grip and rear handle. Use both to best grasp the tool. If both hands are holding saw, they cannot be cut by the blade. Set the base on the workpiece to be cut without the blade making any contact. Then turn the tool on and wait until the blade attains full speed. Now simply move the tool forward over the workpiece surface, keeping it flat and advancing smoothly until the sawing is completed.

To get clean cuts, keep your sawing line straight and your speed of advance uniform. If the cut fails to properly follow your intended cut

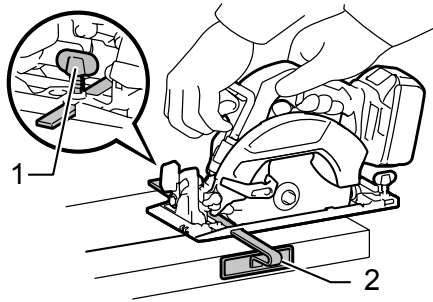

line, do not attempt to turn or force the tool back to the cut line. Doing so may bind the blade and lead to dangerous kickback and possible serious injury. Release switch, wait for blade to stop and then withdraw tool. Realign tool on new cut line, and start cut again. Attempt to avoid positioning which exposes operator to chips and wood dust being ejected from saw. Use eye protection to help avoid injury.

#### Rip fence (Guide rule) (optional accessory)

The handy rip fence allows you to do extra-accurate straight cuts. Simply slide the rip fence up snugly against the side of the workpiece and secure it in position with the clamping screw on the front of the base. It also makes repeated cuts of uniform width possible.

## MAINTENANCE

### **⚠ CAUTION:**

Always be sure that the tool is switched off and the battery cartridge is removed before carrying out any work on the tool.

Clean out the upper and lower guards to ensure there is no accumulated sawdust which may impede the operation of the lower guarding system. A dirty guarding system may limit the proper operation which could result in serious personal injury. The most effective way to accomplish this cleaning is with compressed air. If the dust is being blown out of the guards be sure the proper eye and breathing protection is used.

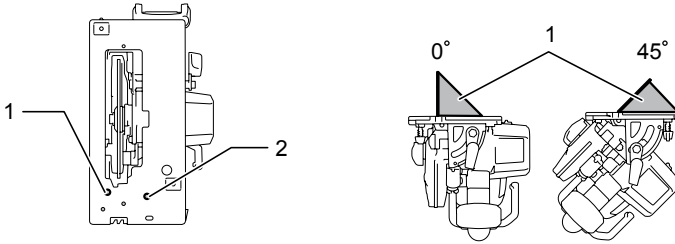

Never use gasoline, benzine, thinner, alcohol or the like. Discoloration, deformation or cracks may result. Adjusting for accuracy of 0° and 45° cut (vertical and 45° cut)

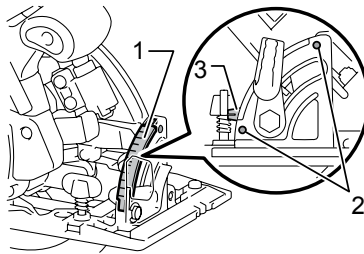

This adjustment has been made at the factory. But if it is off, adjust the adjusting screws with a hex wrench while inspecting 0° or 45° the blade with the base using a triangular rule or square rule, etc. Use the 45° stopper for adjusting 45° angle.

The bevel guide has been factory adjusted. But if it is off, you can adjust it as the following procedure. To adjust the bevel guide, loosen the two screws. Align the 0° line on the bevel guide with the guide on the base when the base is set to 0° angle. To maintain product SAFETY and R LIABILITY, repairs, any other maintenance or adjustment should be performed by RONIX Authorized or Factory Service Centers, always using RONIX replacement parts.

## OPTIONAL ACCESSORIES

### **CAUTION:**

These accessories or attachments are recommended for use with your RONIX tool specified in this manual. The use of any other accessories or attachments might present a risk of injury to persons. Only use accessory or attachment for its stated purpose.

If you need any assistance for more details regarding these accessories, ask your local RONIX Service Center.

- Saw blades
- Rip fence (Guide rule)
- Guide rail
- Guide rail adapter
- Rule bar
- Dust nozzle
- Hex wrench
- RONIX genuine battery and charger

### **NOTE:**

Some items in the list may be included in the tool package as standard accessories. They may differ from country to country.





**Ronix**<sup>®</sup>  
Premium Quality

[www.ronixtools.com](http://www.ronixtools.com)