

Ronix[®]

Premium Quality

ELECTRIC POLISHER 6122

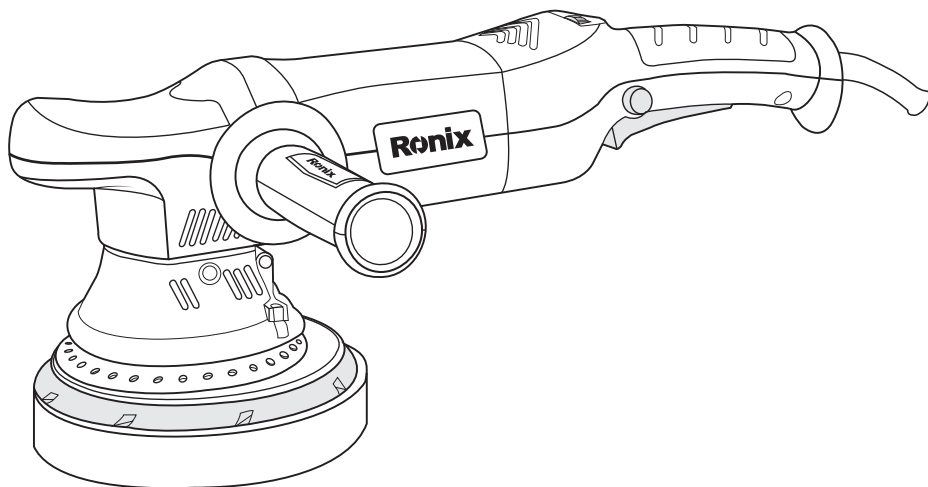

www.ronixtools.com

12
MONTHS
GUARANTY

FREE
DELIVERY

BANK
SPARE PARTS

CALL
CENTER
02161904

SPECIFICATIONS

Model	6122
Rated Voltage	220V
Frequency	50HZ
Input Power	1200W
No Load speed	1600-4500r/min
Disc Capacity	150mm
Net weight	2.85KG
Accessories	hex wrench 1pc carbon brush 2pcs polish disk 1pc manual 1pc side handle 1pc round foam 1pc

PARTS LIST

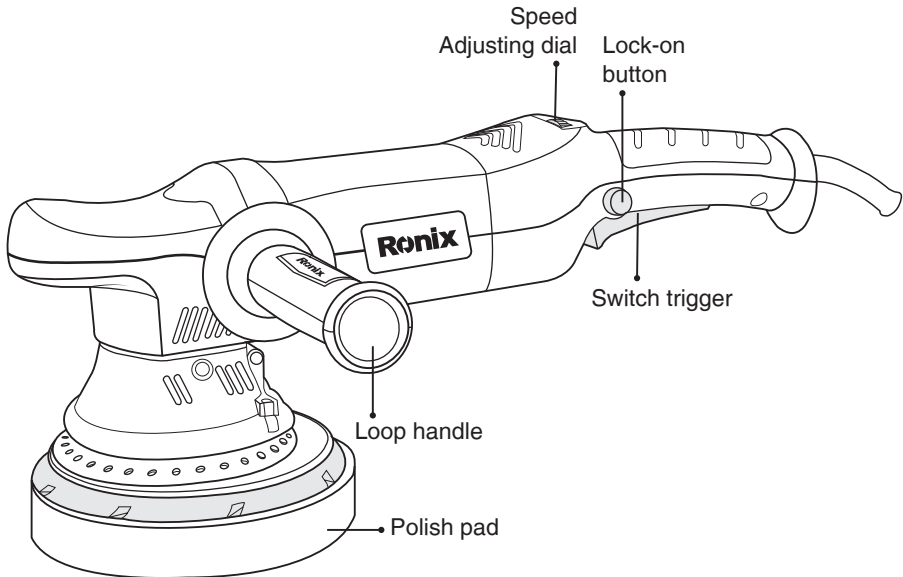

Manufacturer reserves the right to change specifications without notice.

Specifications may differ from country to country.

GENERAL SAFETY RULES

WARNING!

Read and understand all instructions. Failure to follow all instructions listed below, may result in electric shock. Fire and/ or serious personal injury.

SAVE THESE INSTRUCTIONS

■ **WORKS AREA**

- Keep your work area clean and well lit. Cluttered benches and dark areas invite accidents.
- Do not operate power tools in explosive atmospheres, such as in the presence of flammable liquids, gases, or dust. Power tools create sparks which may ignite the dust or fumes.
- Keep bystanders, children and visitors away while operating a power tool. Distractions can cause you to lose control.

■ **ELECTRICAL SAFETY**

- Power tool plugs must match the outlet. Never modify the plugs in any way. Do not use any adapter plugs with earthed power tools. Unmodified plugs and matching outlets will reduce risk of electric shock. Do not change the plug in any way. Double insulation eliminates the need for the three wire grounded power cord and grounded power supply system.
- Avoid body contact with grounded surfaces such as pipes, radiators, ranges and refrigerators. This increases risk of electric shock if your body is grounded.
- Do not expose power tools to rain or wet conditions. Water entering a power tool will increase the risk of electric shock.
- Do not abuse the cord. Never use the cord to carry the tools or pull the plug from an outlet. Keep cord away from heat, oil, sharp edges or moving parts. Replace damaged cords immediately. Damaged cords increase the risk of electric shock.
- When operating a power tool outside, use an outdoor extension cord

marked 'W-A' or 'W'. These cord are rated for outdoor use and reduce the risk of electric shock.

■ PERSONAL SAFETY

- Stay alert, watch what you are doing and use common sense when operating a power tool. Do not use tool while tired or medication. A moment of inattention while operating power tools may result in serious personal injury.
- Dress properly. Do not wear loose clothing or jewelry. Contain long hair. Keep your hair, clothing and gloves away from moving parts. Loos clothes, jewelry, or long hair can be caught in moving parts.
- Avoid accidental starting. Be sure switch is off before plugging in. Carrying tools with your finger on the switch or plugging in tools that have the switch on invites accidents.
- Remove adjusting keys or wrenches before turning the tool on. A wrench or a key that is left attached to a rotating part of the tool may result in personal injury.
- Do not overreach. Keep proper footing and balance at all times. Proper footing and balance enables better control of the tool in unexpected situations.
- Use safety equipment. Always wear eye protection. Dust mask, non-skid safety shoes, hard hat, or hearing protection must be used for appropriate conditions. Ordinary eye or sun glasses are NOT eye protection.

■ TOOL USE AND CARE

- Use clamps or other practical way to secure and support the work piece to a stable platform. Holding the work by hand or against your body is unstable and may lead to loss of control.
- Do not force tool. Use the correct fool for your application. The correct tool will do the job better and safer at the rate for which it is designed.
- Do not use tool id switch does not turn it on or off. Any tool that cannot be controlled with the switch is dangerous and must be repaired.

- Disconnect the plug from the power source before making any adjustments. Changing accessories. Or storing the tool. Such preventive safety measures reduce the risk of starting the tool accidentally.
- Store idle tools out of reach of children and other untrained persons. Tools are dangerous in the hands of untrained users.
- Maintain tools with care. Keep cutting tools sharp and clean. Properly maintained tools with sharp cutting edges are less likely to bind and are easier to control.
- Check for misalignment or binding of moving parts, breakage of parts, and any other condition that may affect the tools operation. If damaged, have the tool serviced before using. Many accidents are caused by poorly maintained tools.
- Use only accessories that are recommended by the manufacturer for your model. Accessories that may be suitable for one tool, may become hazardous when used on another tool.

■SERVICE

- Tool service must be performed only by qualified repair personnel. Service or maintenance performed by unqualified personnel could result in a risk of injury.
- When service a tool, use only identical replacement parts. Follow instructions in the Maintenance section of the manual. Use of unauthorized parts or failure to follow Maintenance instructions may create a risk of electric shock or injury.

■SPECIFIC SAFETY RULES

DO NOT let comfort or familiarity with product (gained from repeated use) replace strict adherence to polisher safety rules. If you use this tool unsafely or incorrectly, you can suffer serious personal injury.

- Accessories must be rated for at least the speed recommended on the tool warning label. Wheels and other accessories running over rated speed can fly apart and cause injury.
- Check the backing pad carefully for cracks, damage or deformity before

operation. Replace cracked, damaged or deformed pad immediately.

- Hold tool by insulated gripping surfaces when performing and operation where the cutting tool may contact hidden wiring or its own cord. Contact with a “live” wire will make exposed metal parts of the tool “live” and shock the operator.

- Always use safety glasses or goggles, Ordinary eye or sun glasses are NOT safety glasses.

- NEVER use tool with wood cutting blades or other sawblades. Such blades when used on a polisher frequently kick and cause loss of control leading to personal injury.

- Hold the tool firmly.

- Keep hands away from rotating parts.

- Make sure the abrasive disc or wool bonnet is not contacting the work piece before the switch is turned on.

- Check that the work piece is properly supported

- Pay attention that the wheel continues to rotate after the tool is switched off.

- When sanding metal surfaces, watch out for flying sparks. Hold the tool so that sparks fly away from you and other persons or flammable materials.

- Do not leave the tool running. Operate the tool only when hand – held.

- Do not touch the work piece immediately after operation: it may be extremely hot and could burn your skin.

- This tool has not been waterproofed, so do not use water on the work piece surface.

- Ventilate your work area adequately when you perform sanding operations.

- Use of this tool to sand some products, paints and wool could expose user to dust containing hazardous substances. Use appropriate respiratory protection.

SAVE THESE INSTRUCTIONS

WARNING!

MISUSE or failure to follow the safety rules stated in this instruction manual may cause serious personal injury.

■SYMBOLS

The following show the symbols used for the tool.

V	voltage
n	no load speed.
A	ampere
--/ min	revolutions or reciprocation per minute
Hz	hertz

CLASS II CONSTRUCTION

■INSTALLING OR REMOVING WOOL BONNET

⚠ CAUTION:

Always be sure that the tool is switched off and unplugged before installing or removing wool bonnet.

- 1) To install the wool bonnet, press the lock shaft and screw the wool bonnet onto the spindle click wise until cannot rotate, then let the lock shaft come back the original position.
- 2) To remove the wool bonnet, only operate the tool according to installing procedure in reverse.

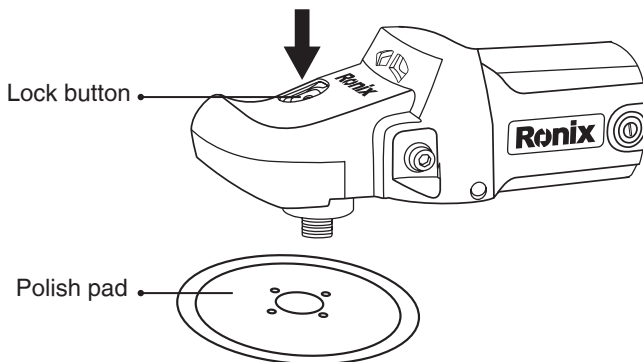

■ INSTALLING THE LOOP HANDLE

Always install the loop handle on the tool before operation. Hold the tool's switch handle and the loop firmly with both hands during operation. Install the loop handle so that its protrusion will fit into the matching hole in the tighten them with the hex wrench. The loop handle can be installed in two different directions whichever is convenient for your work.

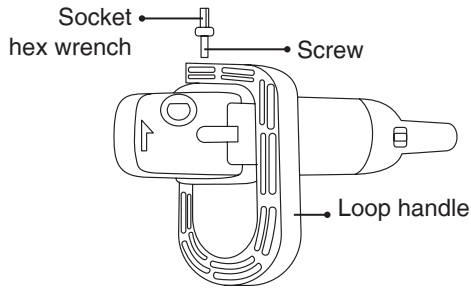

■ SWITCH ACTION

⚠ CAUTION:

- Before plugging in the tool, always check to see that the switch trigger actuates properly and returns to the “OFF” position when released.
- Switch can be locked in “ON” position for ease of operator comfort during extended use. Apply caution when locking tool in “ON” position and maintain firm grasp on tool.

- 1) To start the tool, simply pull the switch trigger. Tool speed is increased by increasing pressure on the switch trigger. Release the switch trigger to stop.
- 2) For continuous operation, pull the switch trigger and then push in the locked position, pull the switch trigger fully, then release it.

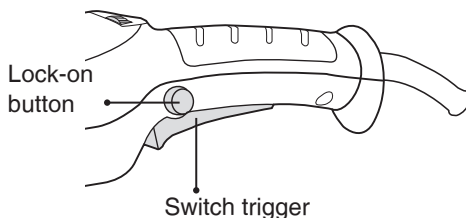

■ SPEED ADJUSTING DIAL

- 1) This tool is equipped with electronic adjusting switch. Usually be set on “1” position before starting.
- 2) The tool speed can be changed by turning the speed adjusting dial to a given number setting from 1 to 6.(At the time when the switch trigger is fully pushed.)
- 3) Higher speed is obtained when the dial is turned in the direction of number 6. And lower speed is obtained when it is turned in the direction of number 1.

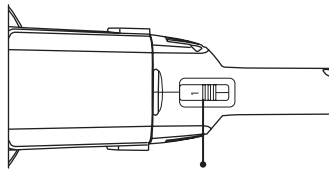

Speed adjusting dial

■ EFFECTIVE AND SAFE FOR POLISHING

- 1) Hold the tool firmly. Turn the tool and the apply the wool bonnet to the work piece. In general, keep the wool bonnet at an angle of about 15 degrees to the work piece surface. Apply slight pressure only as same as the weight of tool. Excessive pressure will result in poor performance and overloading.
- 2) The tool will get good performance for polishing the curve and flat surface.

MAINTENANCE & DAILY CARE

⚠ CAUTION:

Always be sure that the tool is switch off and unplugging before attempting to perform inspection and maintenance.

- 1) The tool and its air vents have to be keep clean, regularly clean the tool's air vents or whenever the vents start to become obstructed.
- 2) Check the all screws if loosened or not periodically.
- 3) Check the cord insulation if broken or not.

■ REPLACING CARBON BRUSHES

- 1) Remove and check the carbon brushes regularly. Replace when the tool occur obvious sparks or ear down to the limit mark.
- 2) Both carbon brushes should be replaced at the same time. Use only Ronix brushes provided
- 3) Use a screwdriver to remove the brush holder caps. Take out the worn carbon brushes, insert the new ones and secure the brush holder caps.

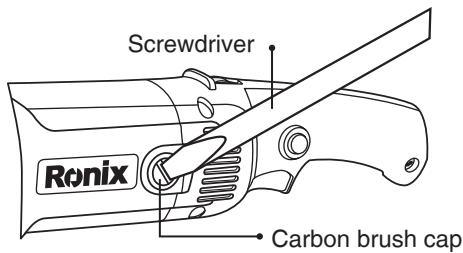

⚠ CAUTION:

Be sure to re-install the knob after inserting new carbon brush. After replacing brushes, plug in the tool break in brushes by running tool with no load for about ten minutes. Then check the tool while running, when releasing the switch trigger. If the tool is not working well, ask your local **Ronix service** center for repair.

To maintain product SAFETY and RELIABILITY, repairs, and other maintenance or adjustment should be performed by Ronix Authorized or Factory service centers, always using Ronix replacement parts.

Ronix[®]
Premium Quality

www.ronixtools.com