

Ronix[®]

Premium Quality

ANGLE GRINDER 180 mm 3270

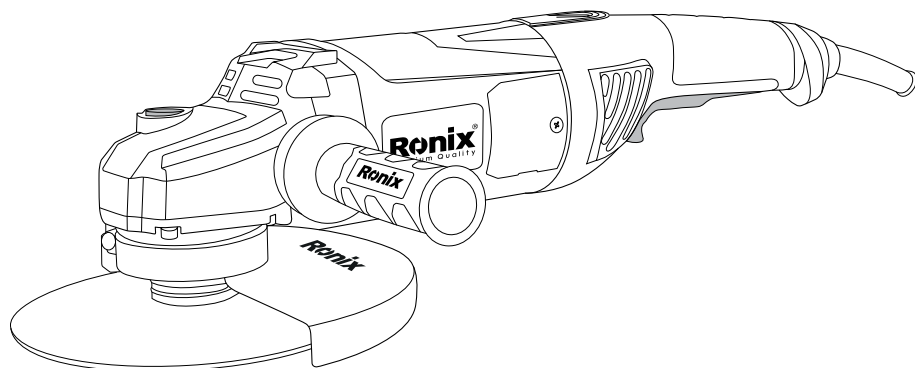

TECHNICAL SPECIFICATION

Model	3270
Power	2800W
No-load Speed	8500RPM
Voltage	220-240V
Frequency	50-60Hz
Wheel Diameter	180mm
Spindle Size	M14
Weight	6.3Kg
Includes	1 set carbon brush, 1 pc wheel guard, 1 pc spanner 1 pc side handle

PART LIST

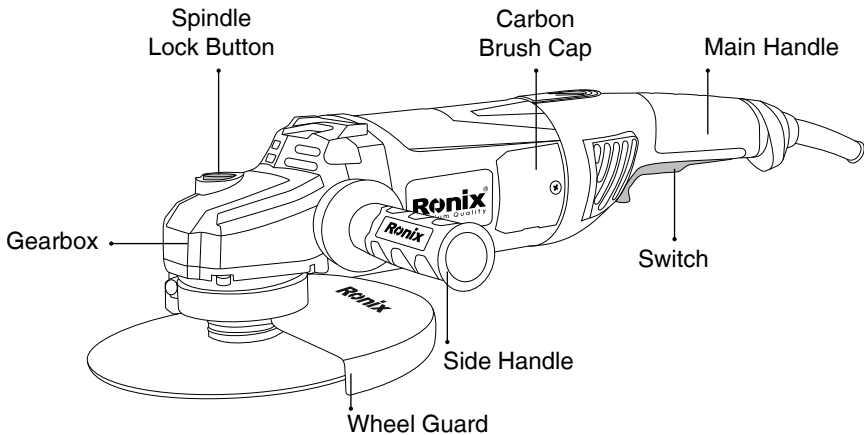

GENERAL POWER TOOL SAFETY WARNINGS

WARNING!

Read all safety warnings and all instructions. Failure to follow the warnings and instructions may result in electric shock, fire and/or serious injury.

Save all warnings and instructions for future reference.

The term “power tool” in the warnings refers to your mains-operated (corded) power tool or battery-operated (cordless) power tool.

■ WORK AREA SAFETY

- a) Keep work area clean and well lit. Cluttered or dark areas invite accidents.
- b) Do not operate power tools in explosive atmospheres, such as in the presence of flammable liquids, gases or dust. Power tools create sparks which may ignite the dust or fumes.
- c) Keep children and bystanders away while operating a power tool. Distractions can cause you to lose control.

■ ELECTRICAL SAFETY

- a) Power tool plugs must match the outlet. Never modify the plug in any way. Do not use any adapter plugs with earthed (grounded) power tools. Unmodified plugs and matching outlets will reduce risk of electric shock.
- b) Avoid body contact with earthed or grounded surfaces, such as pipes, radiators, ranges and refrigerators. There is an increased risk of electric shock if your body is earthed or grounded.
- c) Do not expose power tools to rain or wet conditions. Water entering a power tool will increase the risk of electric shock.
- d) Do not abuse the cord. Never use the cord for carrying, pulling or unplugging the power tool. Keep cord away from heat, oil, sharp edges or moving parts. Damaged or entangled cords increase the risk of electric shock.
- e) When operating a power tool outdoors, use an extension cord

suitable for outdoor use. Use of a cord suitable for outdoor use reduces the risk of electric shock.

f) If operating a power tool in a damp location is unavoidable, use a residual current device (RCD) protected supply. Use of an RCD reduces the risk of electric shock.

NOTE!

The term residual current device (RCD) may be replaced by the term ground fault circuit Interrupter (GFCI) or earth leakage circuit breaker (ELCB).

PERSONAL SAFETY

a) Stay alert, watch what you are doing and use common sense when operating a power tool. Do not use a power tool while you are tired or under the influence of drugs, alcohol or medication. A moment of inattention while operating power tools may result in serious personal injury.

b) Use personal protective equipment. Always wear eye protection. Protective equipment such as dust mask, non-skid safety shoes, hard hat, or hearing protection used for appropriate conditions will reduce personal injuries.

c) Prevent unintentional starting. Ensure the switch is in the off-position before connecting to power source and/or battery pack, picking up or carrying the tool.

Carrying power tools with your finger on the switch or energizing power tools that have the switch on invites accidents.

d) Remove any adjusting key or wrench before turning the power tool on. A wrench or a key left attached to a rotating part of the power tool may result in personal injury.

e) Do not overreach. Keep proper footing and balance at all times. This enables better control of the power tool in unexpected situations.

f) Dress properly. Do not wear loose clothing or jewelry. Keep your hair, clothing and gloves away from moving parts. Loose clothes, jewelry or

long hair can be caught in moving parts.

g) If devices are provided for the connection of dust extraction and collection facilities, ensure these are connected and properly used. Use of dust collection can reduce dust-related hazards.

■ POWER TOOL USE AND CARE

a) Do not force the power tool. Use the correct power tool for your application. The correct power tool will do the job better and safer at the rate for which it was designed.

b) Do not use the power tool if the switch does not turn it on and off. Any power tool that cannot be controlled with the switch is dangerous and must be repaired.

c) Disconnect the plug from the power source and/or the battery pack from the power tool before making any adjustments, changing accessories, or storing power tools. Such preventive safety measures reduce the risk of starting the power tool accidentally.

d) Store idle power tools out of the reach of children and do not allow persons unfamiliar with the power tool or these instructions to operate the power tool. Power tools are dangerous in the hands of untrained users.

e) Maintain power tools. Check for misalignment or binding of moving parts, breakage of parts and any other condition that may affect the power tools operation. If damaged, have the power tool repaired before use. Many accidents are caused by poorly maintained power tools.

f) Keep cutting tools sharp and clean. Properly maintained cutting tools with sharp cutting edges are less likely to bind and are easier to control.

g) Use the power tool, accessories and tool bits etc. in accordance with these instructions, considering the working conditions and the work to be performed. Use of the power tool for operations different from those intended could result in a hazardous situation.

■ SPECIFIC SAFETY RULES

- Always use proper guard with grinding wheel. A guard protects operator from broken wheel fragments.

- Accessories must be rated for at least the speed recommended on the tool warning label. Wheels and other accessories running over rated speed can fly apart and cause injury.
- Hold tool by insulated gripping surfaces when performing an operation where the grinding tool may contact hidden wiring or its own cord. Contact with a “live” wire will make exposed metal parts of the tool “live” and shock the operator.
- Always use safety glasses or goggles. Ordinary eye or sun glasses are NOT safety glasses.
- Check the wheel carefully for cracks or damage before operation. Replace cracked or damaged wheel immediately. Run the tool (with guard) at no load for about a minute, holding tool away from others. If wheel is flawed, it will likely separate during this test.
- Be careful not to damage the spindle, the flange (especially installing surface) and the lock nut. Damage to these parts could result in wheel breakage.
- NEVER use tool with wood cutting blades or other saw blades. Such blades when used on a grinder frequently kick and cause loss of control leading to personal injury.
- Hold the tool firmly.
- Make sure cord is clear of wheel. Do not wrap cord around your arm or wrist. If control of tool is lost, cord may become wrapped around you and cause personal injury.
- Make sure the wheel is not contacting the work piece before the switch is turned on.
- Before using the tool on an actual workpiece, let it run for a while. Watch for vibration or wobbling that could indicate poor installation or a poorly balanced wheel.
- Use the specified surface of the wheel to perform the grinding.
- Watch out for flying sparks. Hold the tool so that sparks fly away from you and other persons or flammable materials.
- Do not touch the work piece immediately after operation; it may be extremely hot and could burn your skin.

PREPARATION FOR USE

■ INSTALLING AUXILIARY HANDLE

- Screw the side grip securely on the position of the tool as shown in the figure.

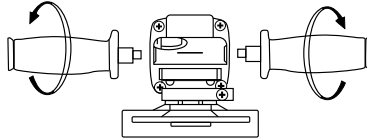

ASSEMBLY THE PROTECTIVE GUARD

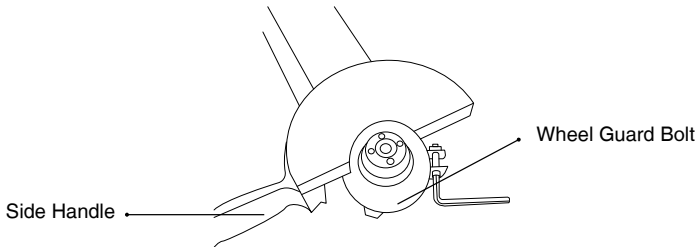

⚠ WARNING!

Prior to assembly and adjustment always switch off the grinder and pull out the power plug from the mains socket.

Use a hex key driver to loosen the Hex Screw and move the protective guard to the desired position and secure it firmly.

The protective guard must be positioned to protect the user if the disc shatters during use.

Check that the spindle lock button is not locked and the spindle can freely rotate. Switch the grinder on using the ON/OFF switch and let it run for 30 seconds to check that it is working correctly and that there are no abnormal vibrations. Stop the grinder immediately if heavy vibration occurs, and investigate the cause.

REPLACING THE GRINDING DISC

⚠ DANGER OF INJURY!

Beware a disc which has been used may be very hot!

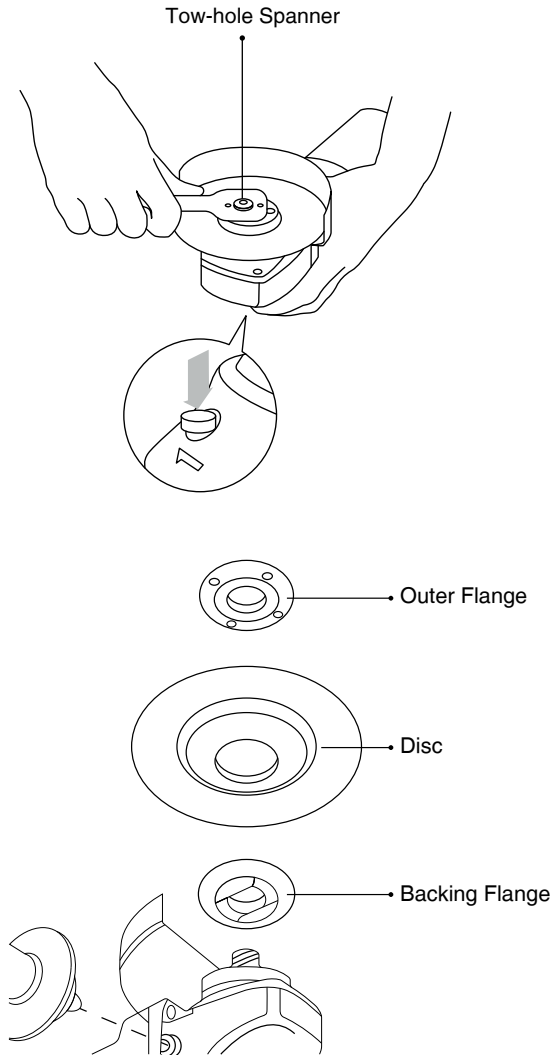

Pull out the power plug from the mains socket.

Depress and hold down the spindle lock button to secure the spindle. Turn the output spindle until it locks. Remove the outer flange and backing flange by using the two-hole spanner provided. Fit the desired disc on the spindle and replace the outer flange and backing flange. Release the spindle lock.

⚠ IMPORTANT:

Only ever press the spindle lock button when the motor and grinder's output spindle are at a standstill!

For cutting up to approx. 3mm thick, screw on the outer flange with the flat side facing the grinding or cutting.

Flange arrangement when using a depressed-center grinding disc.

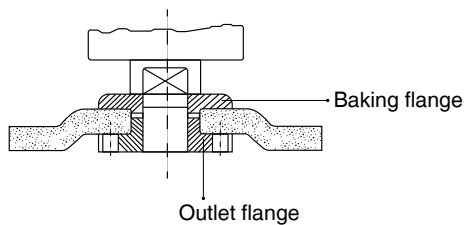

Flange arrangement when using a depressed- center cutting wheel.

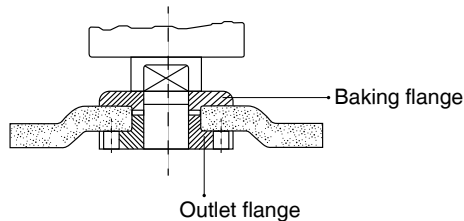

Flange arrangement when using a straight cutting wheel.

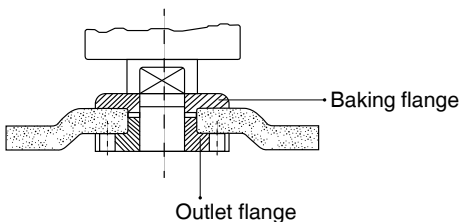

SWITCHING ON / OFF

ATTENTION!

Before working with the angle grinder, check that the voltage shown on the machine's model plate is the same as the mains voltage being used. Before engage the ON/OFF switch button check that the grinding disc is properly fitted and run smoothly, and the outer flange is well tightened.

CONNECT THE PLUG TO THE POWER SUPPLY

■ SWITCHING ON

Switch the angle grinder on by depress the rear position of the ON/OFF switch button as the arrows on the show and pushing the switch button forward and lock onto the "ON" position.

■ SWITCHING OFF

Depress the rear position of the ON/OFF switch button it returns automatically to the "OFF" position and the tool turns off. Do not let go of grinder until it has stopped running.

WARNING:

The wheel continues to rotate after the tool is switched off.

HANDLE ROTATION

To adjusting handle rotation to desired position, press handle button then rotate handle to left and right.

It can rotate between (± 90 degree) to meet the perfect position of left hand or right hand user and make working easier.

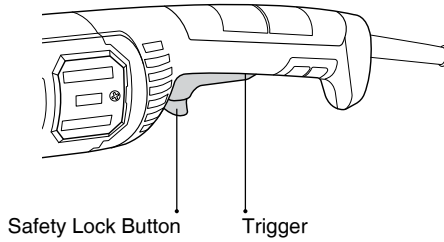

■ USE GRINDING

Hold the handle and auxiliary handle firmly and switch on. Avoid blocking the ventilation slots with your hand, as this may cause the grinder to overheat. Let the disc reach full speed.

Apply the grinder to the item. Maximum effect is achieved when the grinder is held at an angle of 15-30° in relation to the item. Move the grinder gently along the item. Give the grinder time to work. It is rarely necessary to press the disc hard against the surface to be worked.

Sparks can occur in the motor compartment during use. This is normal and does not mean the grinder is defective.

Switch off the grinder after use.

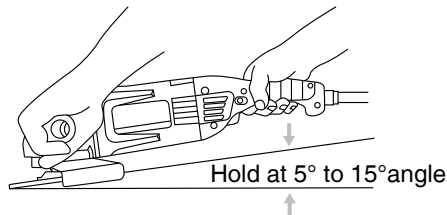

GREAT DANGER OF INJURY!

■ SPLITTING

Splinters of splitting disc may be ejected at a very high speed.

- Do not apply any side pressure to the wheel, as the cutting wheel can jam and burst.

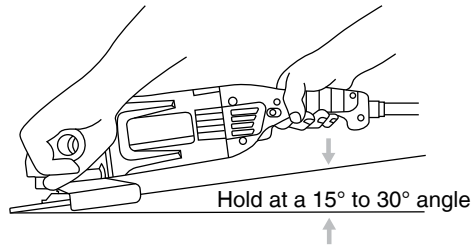

- 1- Fit the splitting disc.
- 2- Switch the tool on and run it first without load.
- 3- Hold the motor block at an angle between 30° and 45° to the workpiece.
4. Guide the disc slowly and evenly along the planned line of cut.

CLEANING AND MAINTENANCE

⚠ DANGEROUS MAINS VOLTAGE!

Danger of electric shock!

Before cleaning, always remove the plug from the mains socket.

Remove dust and dirt with a cloth slightly dampened with detergent solution. In doing so, ensure that no water gets into the machine.

- Clean ventilation slits with a brush.
- The tool is permanently lubricated and does not require oiling. Only used carbon brushes need occasional replacement by new brushes.

ANGLE GRINDER

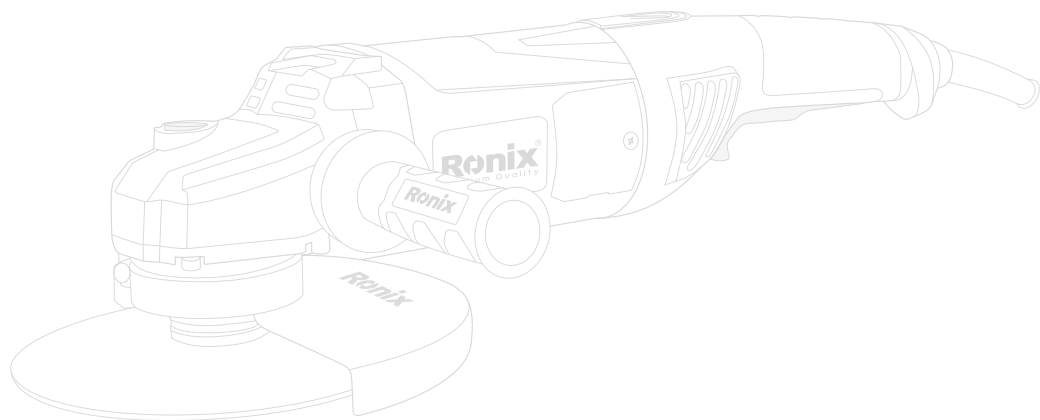

Ronix[®]

Premium Quality

ANGLE GRINDER 180 mm 3270

