

# Ronix<sup>®</sup>

Premium Quality

## MINI ANGLE GRINDER 3110

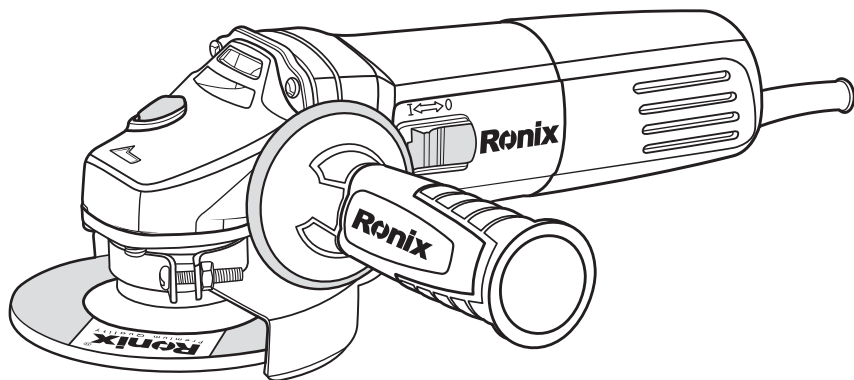

## TECHNICAL SPECIFICATION

Model	3110
Power	880W
Voltage	220-240V
Frequency	50-60Hz
No Load Speed	11000RPM
Cutting Disc Diameter	115mm
Weight	2.2Kg
Accessories	Guard:1pc Spanner:1pc Side Handle:1pc

## PART LIST

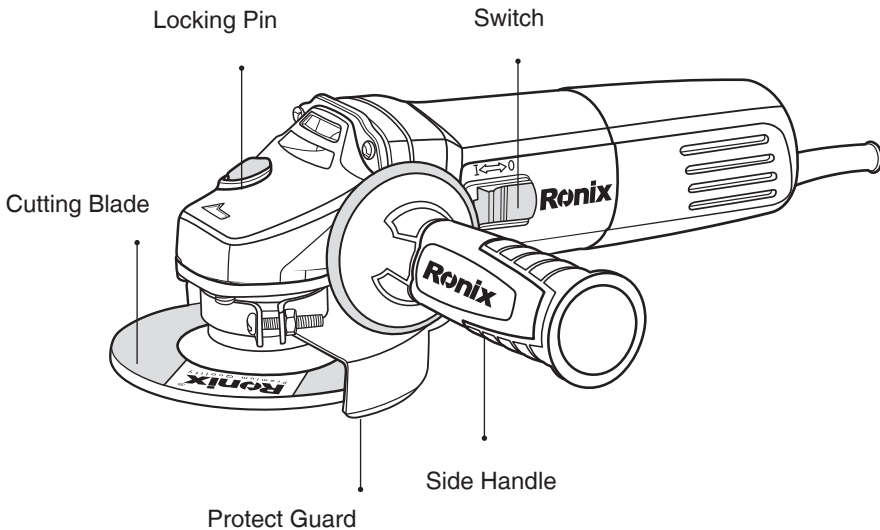

### **⚠ WARNING!**

- When using electric tools, All the safety instructions should always be observed to reduce the risk of fire, electric shock and personal injury before attempting to operate the tools. Please read all the instruction

and save it FOR further refrence.

## **BASIC SAFETY PRECAUTIONS FOR ALL ELECTRIC TOOLS**

### **■ KEEP WORK AREA CLEAN**

- Cluttered area and benches invite injuries.

### **■ CONSIDER WORK AREA ENVIRONMENT**

- Don't use electric tools in damp or wet locations . Don't expose electric tools to rain. Keep work area well-lit in particular, no inflammable liquids or gases must be present.

### **■ AVOID ELECTRIC SHOCK**

- when you are operating tools, don't touch metal being grounded, such as pipe, radiator, freezer,etc.

### **■ KEEP CHILDREN AND VISITORS AWAY**

- Don't let children contact tool or extension cord. All visitors should be kept away from worl place.

### **■ STORE IDEL TOOL**

- when not is use , tools should be stored in dry , high, or locked place.

### **■ DON'T FORCE TOOL**

- It will do the job better and safer at the rate for which it was intended, Avoid unnecessary overload which may put the operator at risk and impair functions of the tools.

### **■ USE RIGHT TOOL**

- Don't force small tools and attachment to do the job of a heavy duty tool. Don't use tools for purpose not intended, for example , don't use electric circular saw for cutting logs or tree limbs.

■ **DRESS PROPERLY**

- Don't wear loose clothes or jewelry . they can be caught in moving parts. Rubber gloves and non-skid footwear are recommended when working outdoors. Wear protective hair covering to contain long hair.

■ **USE SAFETY GOGGLES**

- Always wear safety goggles. If dust is produced, use the special masks.

■ **DON'T ABUSE CABLES**

- Never carry tool by cable or yank it to disconnect it from socket. Keep cable from heat, oil and sharp edges.

■ **DON'T OVERREACH**

- Keep proper footing and balance at all times.

■ **MAINTAIN TOOLS WITH CARE**

- Keep tools sharp and clean for better and safer performance. Follow instructions for lubricating and changing accessories. Inspect tool cords periodically and replace if damaged. Keep handles dry, clean and free from oil and grease.

■ **DISCONNECT TOOLS**

- When not in use, before servicing, and when changing accessories such as blades, bits and cutter.

■ **REMOVE ADJUSTING KEYS AND WRENCHES**

- From the habit of chacking to see that keys and adjusting wrenches are removed from tool before turning it on.

■ **AVOID UNINTENTIONAL STARTING**

- Don't carry plugged-in tool with finger on switch . Make sure switch is off when connecting the plug to the socket.

■ **USE EXTENSION CORD**

- If an extension cord is required, always check that its cross-section measurement is equal to or greater than that of the tool capabilities and so marked.

■ **STAY ALERT**

- Watch what you are doing . Use common sense. Do not operate tool when you are tired.

■ **CHECK DAMAGED PARTS**

- before further use of the tool, a guard or other parts that is damaged should be carefully checked to determine that it will operate properly and perform its intended function . Check for alignment of moving parts, binding of moving parts, breakage of parts,mounting and any other condition that may affect its operations. A guard or other part that is damaged should be properly repaired or replaced by a qualified service center. Do not use tool if switch does not turn on and off.

■ **CHECK THE VOLTAGE**

- Do not plug the electric tool into the mains until you have checked that the voltage shown on data plate corresponds to the voltage available.

■ **REPLACE PARTS**

- The use of improper accessory or attachment other than recommended present a risk of personal injuries.

■ **HAVE YOUR TOOL REPAIRED BY AN EXPERT**

-This electric tool is in accordance with the relevant safety regulation , Repairing of electric tool may be carried out only by expert , otherwise, it may cause considerable danger of the user.

## STRUCTURE AND FUNCTIONS

- The angle grinder is hand-held class II electric power tools with double-insulated structure. Driven by single –phase series motor , and with speed reduced by a pair of spiral bevel gears, the series of tools are widely used for removing burrs from surface of metal part, beveling and fishing weid seams, cutting thin wall tubes and small size metal material, etc in the fields of machines-builing, vehicle manufacturing, chemical engineering . If with its working head changed, this series of tools also is used to clean rust and polish the surface of metal and other material.

## ADDITIONAL SAFETY REGULATIONS

- 1) operator is recommended to wear goggles when operating the tool.
- 2) When operating , the cable of the tool and its extended wire must be placed at the back side of the tool in order to avoid the cable or extended wire being damaged.
- 3) During operating don't hit work piece with grinding disk, when the tool is used to cut small work piece, it mustn't vacillate to the left and right in order to avoid disk being broken. In order to get good result, the slope between the disc and the working surface should be tilted at the angle of 15-30.
- 4) when moving the tool, the user should hold its boby or its handle, never drag the tool by its cable.
- 5) Before using the tool, the tool should be chacked to make sure wheater the disk guard is in good condition and is fasten tightly. The tool without guard is not allowed to be used.
- 6) Before using the tool, please make sure that the disc-installing-disassemble button has been in "0"position , and whether the main spindle of disc of disc can rotate flexibly.
- 7) It is prohibited to use the disk-installing-disassemble button as a brake button when the tool is rotating, otherwise , the tool will be damaged and injury may occur to a person.

8) It is important for you to select fiber reinforced cymbal –type disc whose safety speed is not less than the no load rated speed. It is prohibited to use the disc whose diameter is bigger than that of rated size. The no load speed of this series of tools, please see to the list attached.

9) When making inspection, adjustment , and disc-changing to the tool, does make sure that the plug of the tool has been pulled out of power socket.

10) Before operating the tool, please make sure whether the disc has a breakage or a crack , it shouln't give a voice of breakage or crack when knocked slightly by a wooden hammer

## OPERATION REGULATIONS

### ■ SIDE HANDLE

- Please use side handle for safe and convenient operation.

The side handle can be installed easily in one of the holes on the side of the angle grinder.(Figure 1).

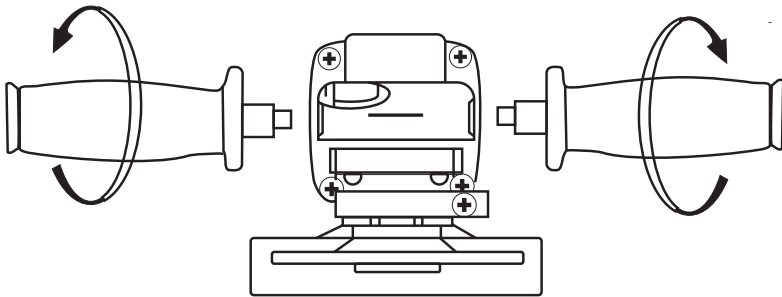

### ■ DISK PROTECT GUARD

#### **▲ WARNING!**

- Before Installing or disassembling the disc, Please make sure the switch is in “0” position and the plug is not connected with socket.

To put the protruding position of protect guard into the slot an front cover, then turning 180 clockwise or anticlockwise.

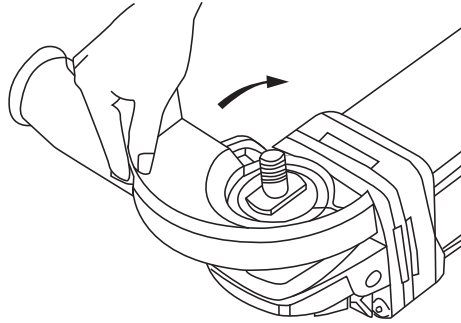

- Fix the screw on protect guard until tightened.(Figure3)

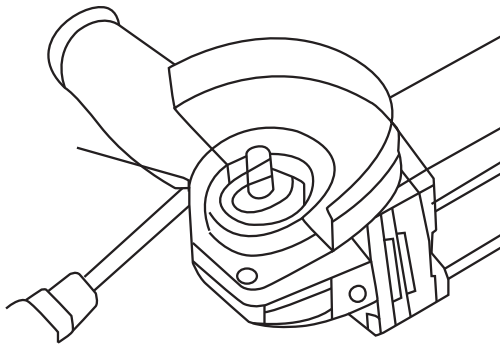

## ■ HOW TO CHANGE THE DISC

### **⚠ WARNING!**

- Before installing or disassembling the disc, please make sure the switch is “0” position and the plug is not connected with socket.
- The max speed of the disc installing 4800 m/min.
- Fix the inner flange onto the spindle, then put the disc onto the inner flange. After that-put the out flange on the spindle.

(Figure 4)



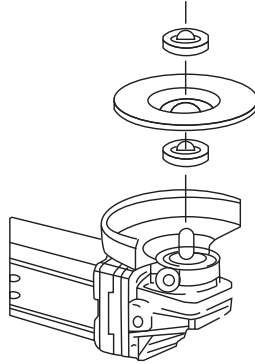

- Press the spindle lock on the gear box, screw the out flange with the flange spanner include in the accessories until the out flange is fastened tightly .(Figure 5)

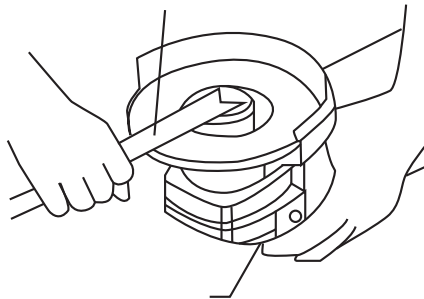

- You can also install or disassemble the disk with two spanners, with one spanner to be installed to upper part of flange to lock the main shaft, and with another spanner to disassemble the flange nut.

**⚠ WARNING!**

- the spindle lock is only used to install and disassemble the disc of the tool. It is prohibited from being used as a brake button when the tool is rotating. Otherwise the tool will be damaged and injury may occur to a person.

## ■ SWITCHED “ON” AND “OFF” OPERATION

### ⚠ WARNING!

- Before plug the angle grinder into the power socket, please make sure the spindle lock is on “0” position.
  - To turn the angle grinder into switch “I” position, then the tool start running.
  - To switch the angle grinder into switch “0” position, then the tool stops.
- (Figure6)

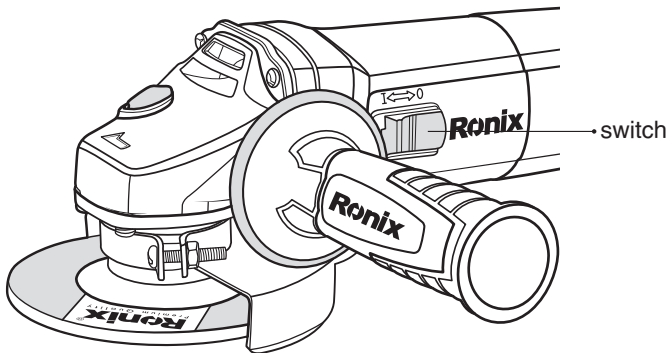

## ■ EFFECTIVE AND SAFELY WORKING METHOD

### ⚠ WARNING!

- It is prohibited to use the tools without the protect guard-To lay down the tools, please make sure the switch is on “0” position and the disc stopped.

- a) Use the correct position on disc, otherwise the disk will be damaged.
- b) To put the strength approximately  $\frac{1}{2}$  weight of the tools itself, then you could get an satisfied effect.

Using the tools with too much force will overload the tool and get the motor and disk damage.

- c) In order to get good result the slope between the disc and the working surface should be titled at the angle of 15-20.

(Figure 7)

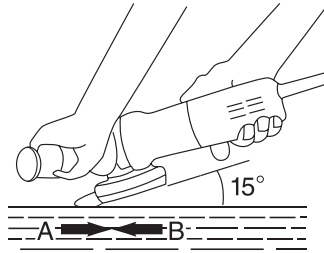

d) when using new disc, don't move the tools in B direction , otherwise the work piece maybe cut off. After the disc become round , then the tools could be moved in both A and B directions.

## SERVICE AND MAINTENANCE

- 1) Always disconnect the tool before carrying out inspection or cleaning. Never use water or other liquids to clean the tool. Clean the tool by brushing it with a brush.
- 2) The air-vent of the tool should be cleaned regularly to avoid the motor too hot due to air –vent blocked.
- 3) Always check if the components of the tool are fixed well.
- 4) The housing should be without trace of crack or damaged.
- 5) Always check if the cable is without damage.

### ■ REPLACING THE CARBON BRUSHES

- a) Replacing the carbon brushes , when the tool couldn't run or too much sparkle.
- b) Carbon brushes which are worn out (burned. Broken or shorter than 5mm have to be replaced by new ones.
- c) Always replace both carbon brushes at the same time and sure the brush by original manufacturer.
- d) Because the carbon brush is internal, so please change the brushes by our maintenance service center.
- e) After placing the new carbon brushes, let the tool run for some minutes so that the brushes fit better.



**Ronix**<sup>®</sup>  
Premium Quality

[www.ronixtools.com](http://www.ronixtools.com)