

Ronix®

Premium Quality

IMPACT DRILL 13MM

2213

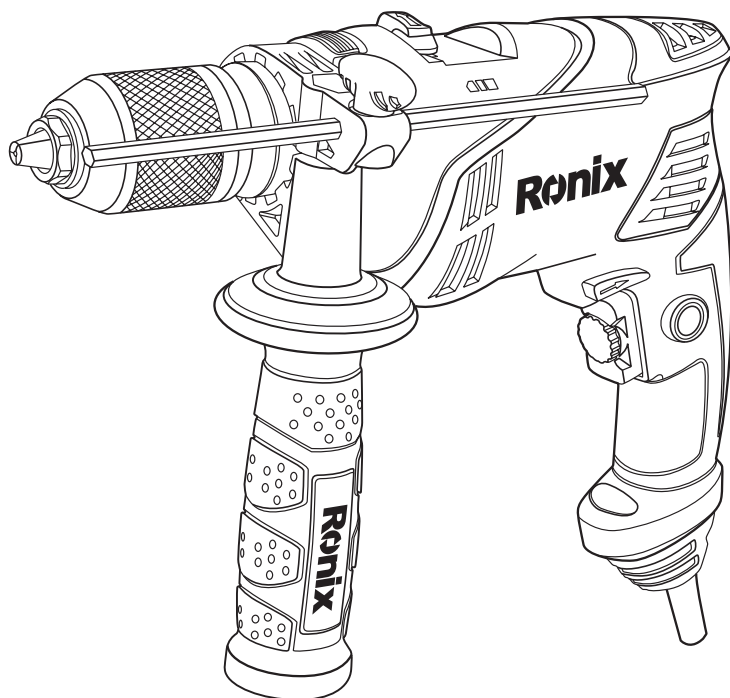

www.ronixtools.com

12
MONTHS
GUARANTY

FREE
DELIVERY

BANK
SPARE PARTS

CALL
CENTER
02161904

TECHNICAL SPECIFICATIONS

Model	2213
Voltage	220v
Frequency	50Hz
Power	650W
Drilling Capacity	1.5-13mm
Steel	13mm
Concrete	13mm
Wood	25mm
No Load Speed	0-3000rpm
Net Weight	2.4Kg

PART LIST

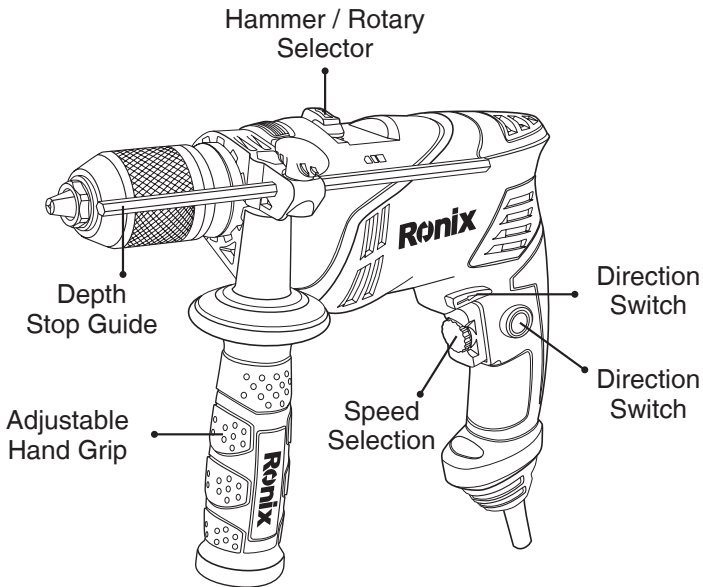

- 1) Speed selection: With the speed selection via the regulator wheel you have optimum control of the machine.
- 2) Lock button: The machine can be set to continuous operation with locking button.
- 3) Adjustable Hand grip: The second handle gives you an additional way the holding the machine firmly.
- 4) Hammer / rotary selector: Depending on the position of the percussion drilling/drilling switch you can use your drilling machine as a percussion drill or rotating drill.
- 5) Direction: The direction switch controls the direction of motion when the machine is used as a screwdriver or if you would like to remove a drilling bit that has become jammed.
- 6) Depth Stop Guide: Using the adjustable bit stop you can fix depth of blind holes accurately during drilling.

OPERATING INSTRUCTIONS

Please read the operation instructions meticulously and pay particular attention to the safety instructions.

WARNING!

For your personal safety, read and understand before using.

GENERAL SAFETY INSTRUCTION

■ WORK AREA

- Keep your work area clean and well lit. Cluttered benches and dark areas invite accidents.
- Flammable liquids, gases, or dust. Power tools create sparks which may ignite the dust or fumes. Do not operate power tools in explosive atmospheres, such as in the presence of flammable liquids, gases, or dust.
- Keep bystanders, children, and visitors away while operating a power

tool. Distractions can cause you to lose control.

■ ELECTRICAL SAFETY

- Power tool plugs must match the outlet. Never modify the plug in any way. Do not use any adapter plugs with earthed (grounded) power tools. Unmodified plugs and matching outlets will reduce risk of electrical shock.
- Avoid body contact with earthed or grounded surface such as pipes, radiators, ranges and refrigerators. There is an increased risk of electric shock if your body is earthed or grounded.
- Do not expose power tools to rain wet conditions. Water entering a power tool will increase the risk of electric shock.
- Do not abuse the cord. Never use the cord of carrying, pulling or unplugging the power tool. Keep cord away from heat, oil sharp edges or moving parts. Damaged or entangled cords increase the risk of electric shock.
- when operating a power tool outdoors, use an extension cord suitable use. Use of a cord suitable for outdoor use reduces the risk of electric shock.

■ PERSONAL SAFETY

- Stay alert, watch what you are doing and use common sense when operating a power tool. Do not use a power tool while you are tired or under the influence of drugs, alcohol or medication. A moment of inattention while operating power tools may result in serious injury.
- use safety equipment. Always wear eye protection safety equipment such as dust mask, nonskid safety shoes, hard hat, or hearing protection used for appropriate conditions will reduce personal injuries.
- Avoid accident starting. Ensure the switch is in the off position before plugging in. carrying power tools with your finger on the switch or plugging power tools that have the switch on invites accident.
- Remove any adjusting key or wrench before turning the power tool on. A wrench before turning the power tool on. A wrench or a key left attached to a rotating part of the power tool may result in personal injury.
- Do not overreach. Keep proper footing and balance at all times. This enables better control of the power tool in unexpected situations.

- Dress properly. Do not wear loose clothing or jewelry. Keep your hair, clothing and gloves away from moving parts. Loose clothes, jewelry or long hair can be caught in moving parts.

■ **TOOL USE AND CARE**

- Do not force the power tool. Use the correct power tool for your application. The correct power tool will do the job better and safer at the rate for which it was designed.

- Do not use the power tool if the switch does not turn it on and off, my power tool that cannot be controlled with the switch is dangerous and must be repaired.

- Disconnect the plug from the power source before making any adjustments, changing accessories, or storing power tools. Such preventive safety measures reduce the risk of starting the power tool accidentally.

- Store idle power tools out of the reach of children and do not allow persons unfamiliar with the power tool or these instructions to operate the power tool. Power tools are dangerous in the hands of untrained users.

- Maintain power tools. Check for misalignment or binding of moving parts, breakage of parts and any other condition that may affect the power tools operation. If damaged, have the power tool repaired before use. Many accidents are caused by poorly maintained power tools.

- Keep cutting tools sharp and clean. Properly maintained cutting tools with sharp cutting edges are less likely to bind and are easier to control.

- Use the power tool, accessories and tool bits etc., in accordance with these Instructions and in the manner intended for the particular type of power tool, taking into account the working conditions and the work to be performed. Use of the power tool for operations different from intended could result in a hazardous situation.

■ **SERVICE**

- Have your power tool Serviced by a qualified repair person at **RONIX SERVICE** using only identical replacement parts. This will ensure that

the safety of the power tool is maintained.

■ ADDITIONAL SAFETY INSTRUCTIONS

- Wear ear protectors with impact drills. Exposure to noise can cause hearing loss.
- Use auxiliary handles supplied with the tool. Loss of control can cause personal injury.

▲ WARNING!

- For your own safety always use only the accessories and attachments specified in the operating instructions. The use of accessories and attachments other than those specified in the operating instructions can cause injuries!
- Always have your tool be repaired by certified technicians at RONIX SERVICE center!
- This tool meets the relevant safety requirements!
- During operating, wear hearing protection to avoid damage to your hearing!

OPERATION AND USE

▲ WARNING!

When performing the following work, always ensure that the machine is not connected to the mains power supply.

■ INSERTING THE SECOND HANDLE

In order to assemble the second handle, release it by rotating lower part anti-clockwise so that you can easily pull the handle over the drill chuck on the flange located behind it. Then turn the handle to working position that is comfortable for you and fix it in place by tightening it (rotating the lower part clockwise)

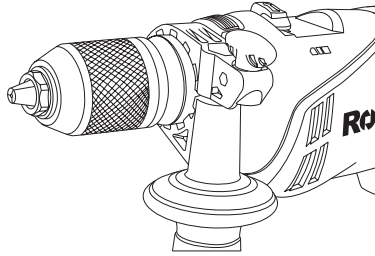

■ ADJUSTING DEPTH STOP GUIDE

The second handle has a retainer for the Stop Guide.
Insert a drill.

Now release the handle.

Push the Stop Guide forwards until its end is in line with the end of the drill.
Now push the bit stop back until the distance between the end of the bit and the end of the drill corresponds to the depth to which you would like to drill.

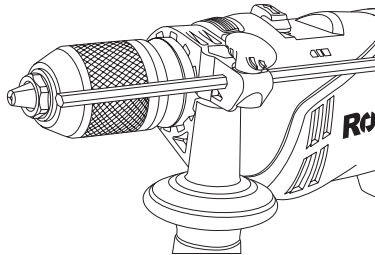

■ INSERTING THE DRILL

First remove the mains supply from the socket. Turn the ring of the drill chuck until the clamping jaws are open wide enough. Insert the drill into the clamping jaws of the drill chuck. Insert the end of the drill chuck key into one of the three holes on the body of the drill chuck and let the head of the key lock into place in the ring of the drill chuck in order to lighten the clamping jaws and fix the drill in place. Turn the drill chuck key in a clockwise direction. Important: Then remove the key from the chuck.

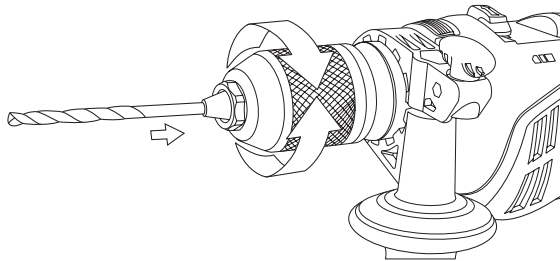
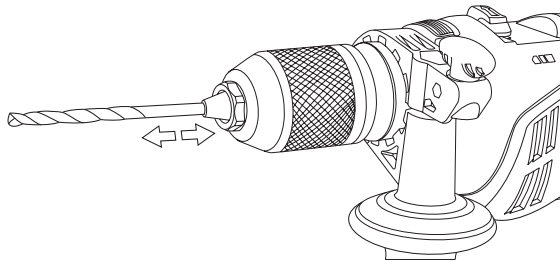
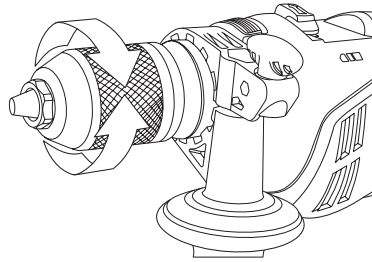

WORKING WITH THE DRILLING MACHINE

Ensure that the mains power supply voltage is the same as the operating voltage of your machine. For details, please see the type plate. Insert the correct drill for the type of job to be performed. If necessary, adjust the bit stop.

The more the operating switch is pressed in, the faster the drill rotates. Set the direction switch to the desired direction of motion. Never alter the position of the percussion drilling switch or the direction switch when the machine is switched on. The machine is switched on by pressing the

operating switch. When the operating switch is released, the machine stop. If you would like to use continuous operation press the locking button while the operating switch is pressed. In order to switch off the machine during continuous operation, press the operating switch again the operating switch again and then let it go. Do not touch the drill chuck while the machine is switched on.

DRILLING TIPS

- Always insert the correct size and drill or screwdriver.
- Set the machine to the correct speed.
- Always hold the machine tightly by the handle and second handle.
- When drilling wood and metal, set the percussion drilling switch to drilling.
- When drilling masonry, set the percussion-drilling switch to percussion drilling.
- When using the machine as a screwdriver, set the percussion- drilling switch to drilling.
- Set the direction switch to the correct direction.
- Never change the direction of motion when the machine is switched on.

CARE OF THE TOOLS

■ OVERLOAD

Never use excessive force when drilling. Too much pressure reduces the speed of the machine, and the required power is greatly reduced. This may result in overload, which can damage the motor of the drilling machine. When the drilling machine becomes too hot, allow it to run for two minutes without a load and then interrupt working for a short time. Clean the drilling machine with a clean cloth and a brush. Ensure that the ventilation slits not blocked.

This appliance conforms to CE directive for radio interference suppression and low-voltage safety and has been built to meet current safety

requirements. Subject to technical changes without prior notice!

 WARNING!

When servicing, use only identical replacement parts. Use of any other parts may create a hazard or cause product damage. To ensure safety and reliability, all repairs should be performed by a qualified service technician at RONIX SERVICE Center.

Ronix[®]
Premium Quality