

Ronix[®]

Premium Quality

WET & DRY VACUUM CLEANER 30L

1230

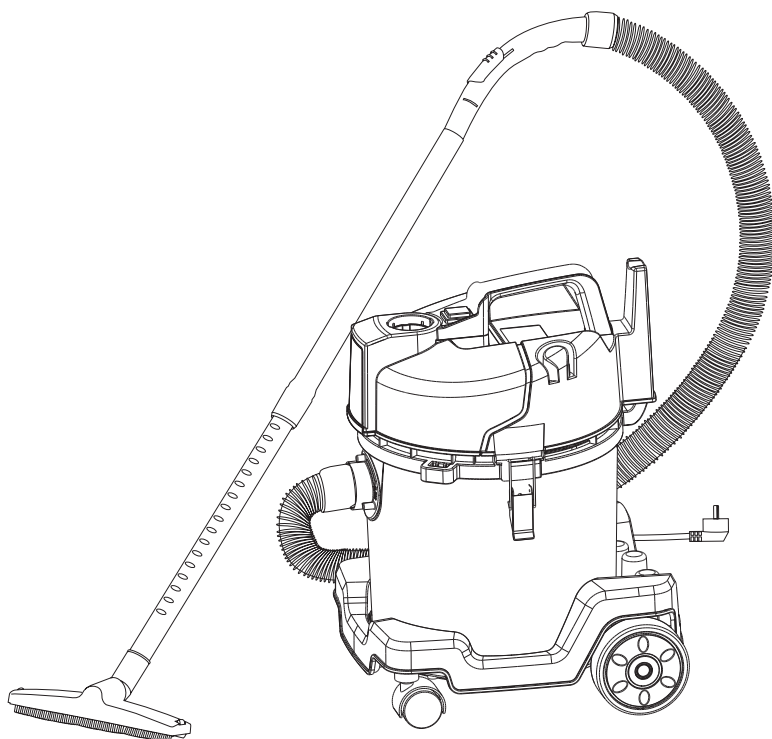

www.ronixtools.com

12
MONTHS
GUARANTY

FREE
DELIVERY

BANK
SPARE PARTS

CALL
CENTER
02161904

SPECIFICATIONS

Model	1230
Tank Capacity	30 L
Power	1400 W
Voltage	230 V
Frequency	50Hz
Air Flow	1.9 m ³ /min
Pressure	18 Kpa

PARTS LIST

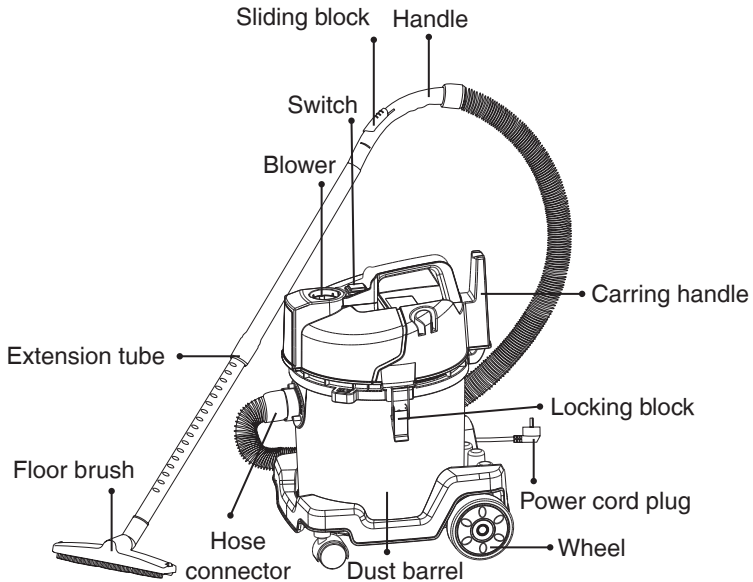

SAFETY DIRECTION

■ IMPORTANT SAFE GUARD

When using an electrical appliance, basic precautions should always be followed, including the following:

READ ALL INSTRUCTIONS BEFORE USING THIS VACUUM CLEANER.

WARNING!

To reduce the risk of fire, electric shock, or injury:

- Do not use outdoors.
- Do not leave vacuum cleaner when plugged in. Turn off the switch and unplug the electrical cord when not in use and before servicing.
- Do not allow to be used as a toy. Close attention is necessary when used by or near children.
- Use only as described in this manual. Use only manufacturers recommended attachments.
- Do not use with damaged cord or plug.
- Do not pull or carry by cord, use cord as a handle, close door on cord, or pull cord around sharp edges or corners. Do not run vacuum cleaner over cord. Keep cord away from heated surfaces.
- Do not use extension cords or outlets with inadequate current carrying capacity.
- Turn off all controls before unplugging.
- Do not unplug by pulling on cord. To unplug, grasp the plug, not the cord.
- Do not handle plug or vacuum cleaner with wet hands or operate without shoes.
- Do not put any object into openings. Do not use with any opening blocked: keep free of dust, lint, hair, and anything that may reduce airflow. revolving brush roll. Keep hair, loose clothing, fingers, and all parts of body away from openings and moving parts.
- Do not pick up anything that is burning or smoking, such as cigarettes, matches, or hot ashes.
- Do not use without dust cup or filter in place.

- Use extra care when cleaning on stairs.
- Do not use to pick up flammable or combustible liquids such as gasoline, or use in areas where they may be present.
- Store your cleaner indoors in a cool, dry area.
- ENSURE you turn the unit off at the very minimum every 15 minutes (for 1 minute) to let the motor cool down - failure to do so may cause motor failure.
- DO NOT use this unit for more than 4 hours (including rest breaks) on any given day.

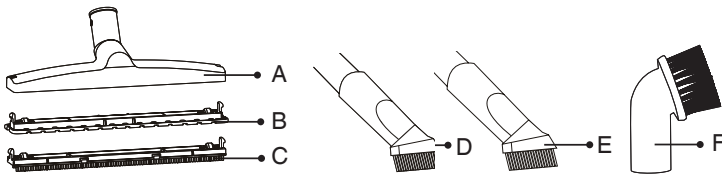

- A) Carpet use
- B) Floor use
- C) Humidity picking up use
- D) Service nozzle for corners, cracks, etc.
- E) Bristle brush for sofa, bookshelf, curtain and furniture, etc.
- F) Round Brush

OPERATION METHOD

- 1- Release the lock block to open the up housing. take out wheels and accessories.

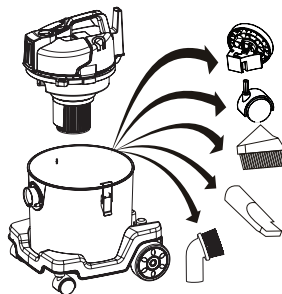

- 2- (1) Install castor wheels into the hole on the base.
(2) Install the big wheel into the relevant position and then fix the wheel with screw. Please kindly keep the mark on the big wheel («R» or «L») same as the one («R» or «L») on wheel base.

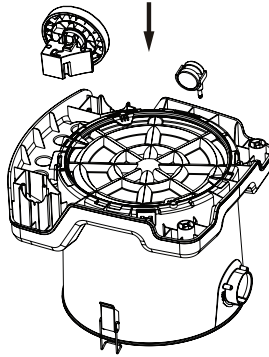

- 3- Put the hose connector into (1), the suction function is available Put the hose connector into (2) the blow function is available

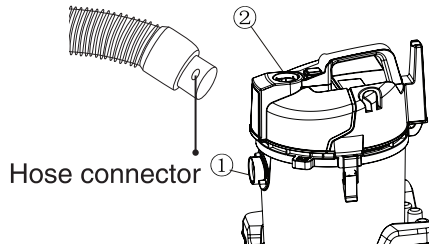

- 4- Insert the handle into the tube with a twisting force. Same as above

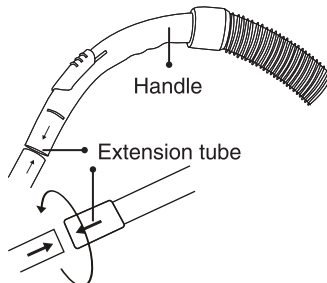

5- Same as picture one

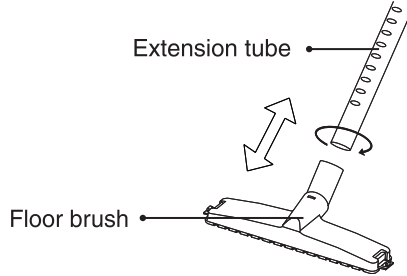

6- Hold the plug and insert into socket.

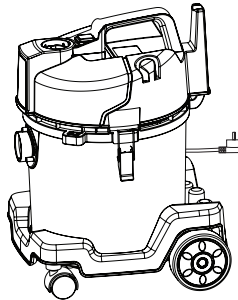

7- Only choosing (AUTO) button, vacuum cleaner works while the electric tool dose vacuum cleaner stops working after electric tool is closed. Only choosing 1nbutton, vacuum cleaner works yet the electric tool doesn` t work When the (AUTO) button and (I) button is in the same level, bosh the vacuum cleaner and electric tool don` t work for the electricity is cut off.Switch off the power tool when plug in or/and VC Switch is being adjusted. The max load of the power tool socket is 2000W.

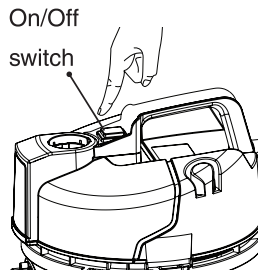

8- You can adjust the airflow by push the sliding block up and down.

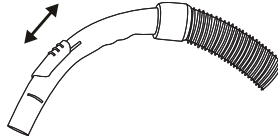

TO REPLACE DUST BAG

If the dust barrel is full, please empty it as soon as possible

- 1) Release the lock block to open the up housing
- 2) Empty the dust barrel
- 3) Put back the up housing, and fasten the locking block.

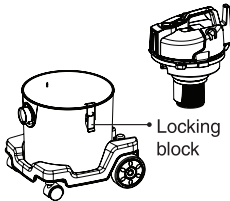

Figure 1

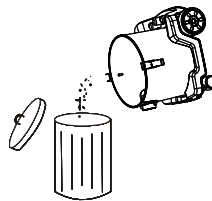

Figure 2

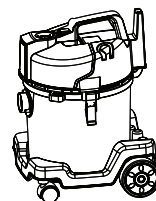

Figure 3

MAINTENANCE

WARNING!

When the filters are obviously covered with dust or the suction decreases considerably, please clean it in time, for this can improve the working efficiency and extend the life time of the cleaner.

Never: use the machine without filters.

- 1) Twist the locking knob with a anti-clockwise force, take off the filters.

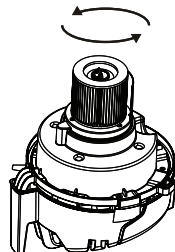

2) Clean it carefully

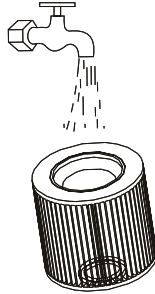

3) Dry by airing

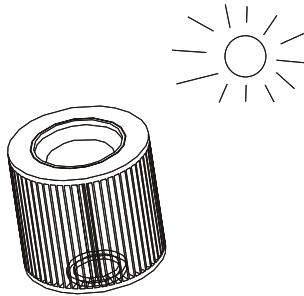

4) Put back the filter

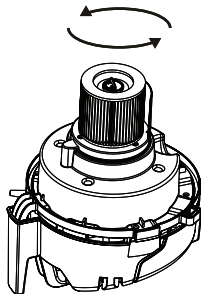

Ronix[®]
Premium Quality

www.ronixtools.com