

Ronix[®]

Premium Quality

GASOLINE CHAIN SAW 4650

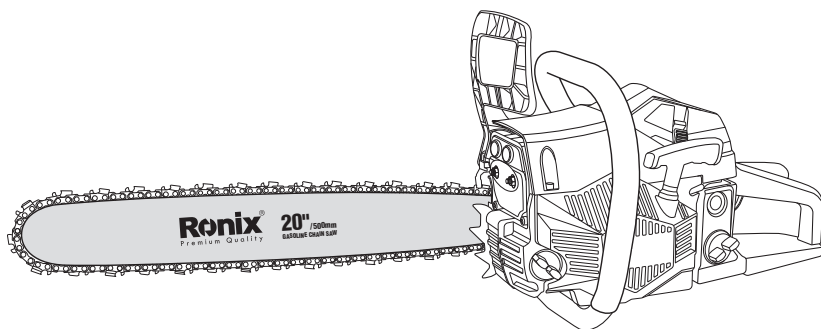

TECHNICAL SPECIFICATION

Model	4650
Engine Power	2300W
Guide Bar Length	20in/50cm
Cutting Capacity	50cm
Fuel Capacity	550ml
Displacement	54.5cm ³
Power Source	gasoline
Oil Tank Capacity	260ml
Carburetor	Diaphragm type
Idling Speed Range	3000±300RPM
Max Speed with Cutting Attachment	8500RPM
Ignition System	C.D.I with timing advance function
Oil Feeding System	Mechanical plunger pump with adjuster
Guide Bar Size	20 Inch
Guide Bar Type	Sprocket nose
Weight	8.5kg
Spplied in	Ronix Color Carton
Includes	Chain saw, Guide bar, Guide bar sleeve, Bottle, Screwdriver, Rasper, Plug wrench, Oil cup

PART LIST

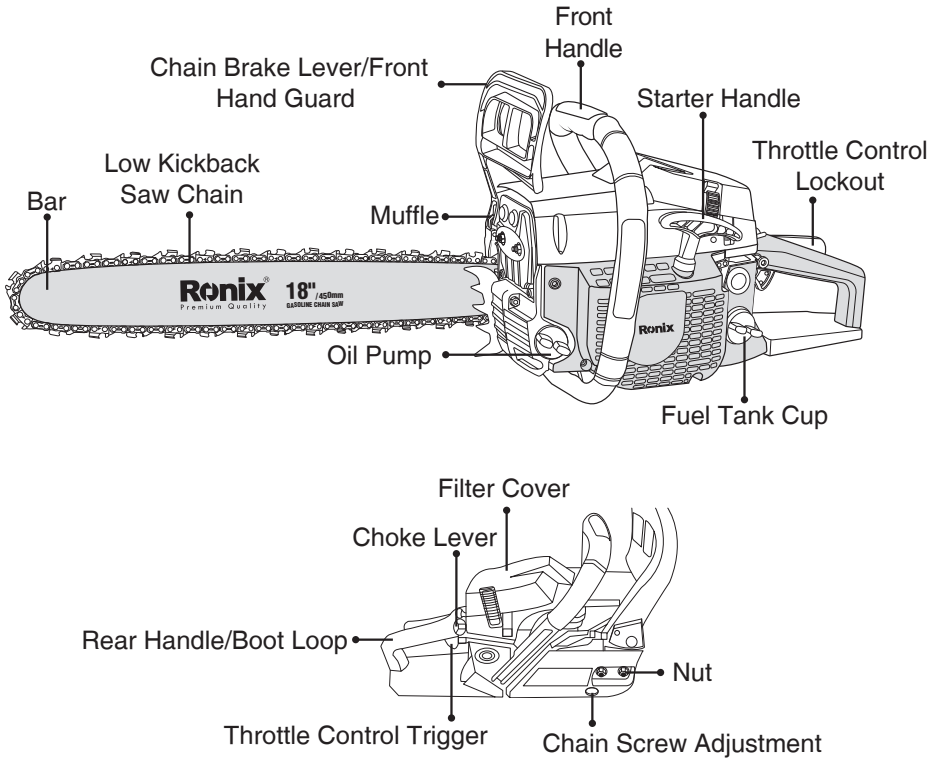

IMPORTANT SAFETY INSTRUCTIONS

SAFETY ALERT SYMBOLS

Safety alert symbols are used to draw your attention to possible dangers. These symbols, and their explanations, deserve your careful attention and understanding. The safety warnings do not by themselves eliminate any danger. The instructions or warnings they give are not substitutes for proper accident prevention measures. These safety instructions are not meant to cover every possible condition that may occur.

BASIC SAFETY PRECAUTIONS

DO NOT rely exclusively upon the safety devices built into the unit.

DO NOT allow the unit to be used as a toy.

Please read the entire operator's manual carefully before attempting to assemble, operate or maintain the unit.

Follow all safety instructions. Failure to do so can result in property damage or serious injury to yourself and/or others.

Be thoroughly familiar with the controls and the proper use of the unit.

Know how to stop the unit and disengage the controls quickly.

Stay alert! Do not operate the unit when tired, ill or under the influence of alcohol, drugs or medication.

Never allow children to operate the unit. Never allow adults to operate the unit without proper instruction.

Make sure that all guards and safety attachments are properly installed before operating the unit.

Keep these instructions. Refer to them often and use them to instruct other users. If loaning someone this unit, also loan them these instructions.

Keep bystanders, especially children and pets, at least 50 feet (15 m) away. If anyone enters the work area, stop the unit!

Keep the work area clean. Cluttered areas invite injuries. Do not start cutting until the work area is clear and free from obstructions, there is secure footing and a planned retreat path from falling branches.

Always wear appropriate eye and ear/hearing protection when operating this unit. Wear safety goggles, or safety glasses with side shields failure to do so could result in serious eye injury caused by thrown or falling objects. If the operation is dusty, wear a facemask or dust mask. Use a hard hat or other type of safety helmet.

Dress appropriately, wear heavy, snug-fitting clothes (long pants and a long sleeve shirt), non-slip protective gloves and steel-toed safety boots. Do not wear loose clothing, jewelry, short pants, sandals or go barefoot. Secure hair above shoulder level to prevent entanglement in moving parts.

Only use the unit in daylight or good artificial light.

Only use the unit for its intended purpose: to cut wood. Only use the unit as described in this manual. Only use the manufacturer's recommended attachments with this unit.

Rotational Kickback can happen when the upper tip of the guide bar contacts an object while the chain is moving (Fig. 1&2). This can cause the chain to dig into the object and momentarily stop moving. The guide bar is then kicked up and back toward the operator in a lightning-fast reverse reaction.

- Pinch Kickback can happen when the wood on either side of a cut closes in and pinches the moving saw chain along the top of the guide bar. This can cause the chain to instantly stop. The chain force is then reversed, causing the saw to move in the opposite direction, sending the saw straight back toward the operator.

- Pull-In can happen when the moving chain on the bottom of the guide bar hits a foreign object inside the wood. This can cause the chain to suddenly stop. The saw is then pulled forward and away from the operator, which could potentially result in the loss of control of the saw.

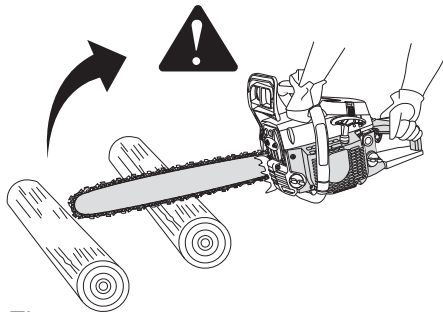

Fig. 1

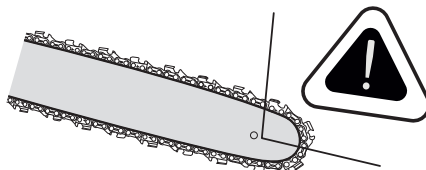

Fig. 2

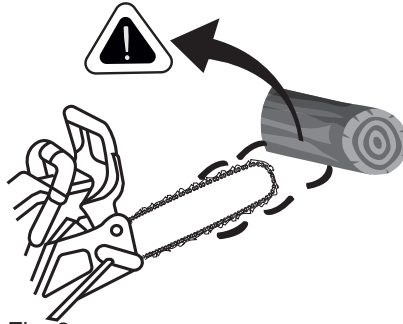

Fig. 3

KICKBACK SAFETY PRECAUTIONS

- DO NOT over reach.
- DO NOT cut above shoulder height.
- DO NOT make cuts with the tip of the guide bar (Fig.1).
- DO NOT let the tip of the guide bar contact any object, such as a log, branch, ground or other obstruction. Remove or avoid any obstructions that might impact the tip of the guide bar while cutting (Fig.3).
- DO NOT cut more than one log or branch at a time.
- DO NOT twist the saw when removing the guide bar from an undercut while bucking.
- DO NOT operate the unit with one hand! Serious injury to the operator, helpers or bystanders may result from one-handed operation. This unit is intended for two-handed use. Always grip the unit firmly with both hands when the engine is running. Keep the left hand on the front handle and the right hand on the rear handle. Use a firm grip with thumbs and fingers encircling the handles. A firm grip will help maintain control of the unit and reduce kickback.
- DO NOT install a bow guide on this unit. Bow guides have a larger kickback zone, which increases the chance of kickback and serious injury. This increased risk is not significantly reduced by using a low kickback saw chain.

Using a bow guide on this unit is extremely dangerous. Never start the

saw when the guide bar is inside an existing cut. Be extremely careful when re-entering a cut.

Keep proper footing and balance at all times.

- Always begin a cut with the engine running a full speed. Fully squeeze the throttle control trigger and maintain a steady cutting speed. Slower speeds increase the chance of kickback. Keep the saw housing pressed firmly against the wood.

- Watch for shifting logs, branches, or other objects that might pinch, or fall onto the chain while cutting.

- If using wedges, Only use wedges made of plastic or wood. Do not use metal to hold a cut open.

- Follow the manufacturer's sharpening and maintenance instructions for the saw chain.

- Only use replacement guide bars and chains specified by the manufacturer or the equivalent.

These are available from authorized service dealers. Use of any unauthorized parts or accessories could lead to serious injury to the operator or damage to the unit and will void the warranty.

- Use devices, such as low-kickback chains, guide bar nose guards, chain brakes and special guide bars, which reduce the risks associated with kickback.

GENERAL SAFETY PRECUATIONS

- DO NOT handle the unit with wet hands.

DO NOT operate a chain saw in a tree or on a ladder unless specifically trained to do so.

DO NOT use the unit in the presence of flammable liquids or gases.

DO NOT operate a unit that is damaged, improperly adjusted or not completely and securely assembled. Be sure that the saw chain stops moving when the throttle control trigger is released. Do not use the unit if the stop switch does not turn the unit on and off properly or if the lockout switch does not work. Have defective switches replaced by an

authorized service center.

DO NOT attempt operations beyond the operator's capacity or experience.

DO NOT cut near electrical cables or power lines.

- DO NOT force the chain saw, especially near the end of a cut. It will do a better, safer job when used at the intended rate.

DO NOT touch the engine or muffler. These parts can become extremely hot during operation and remain hot for a short time after the unit is turned off.

- To reduce the risk of fire, keep the engine and muffler free from debris, excessive grease and carbon build up.

- Before cutting, always inspect wood for foreign objects that could cause injury to the operator or damage to the unit. Never cut through nails, metal rods, railroad ties or pallets. If a foreign object is struck, stop the unit and inspect it for damage.

- Keep all body parts away from the saw chain when the engine is running. Before starting the saw, make sure the saw chain is not contacting anything.

- Always stop the engine when operation is delayed, before setting down the unit or when walking from one location to another. Make sure the chain comes to a complete stop. Do not leave the unit unattended while the engine is running. Always stop the engine when not in use.

- To avoid accidental starting, never carry the unit with fingers on the throttle control trigger. Only pull the starter rope when in the starting position. The operator and unit must be in a stable position while starting the engine. Refer to Starting and stopping instructions.

- Always carry the chain saw by the front handle with the engine off, finger off the throttle control trigger, the muffler positioned away from the body and the guide bar and saw chain sheathed in the scabbard and positioned to the rear.

- Always make sure the stop switch is in the proper position before starting or stopping the engine.

- When cutting a limb that is under tension, be alert for spring back, which may cause the operator to be struck when the tension of the wood fibers is cause the operator to be struck when the tension of the wood

fibers is released.

- Use extreme caution when cutting small-sized brush and saplings, as slender material may catch the saw chain and be whipped toward the operator or pull the operator off balance.

MAINTENANCE AND STORAGE SAFETY

If the unit is not working as it should, has been dropped, damaged, left outdoors or dropped into water, do not use the unit. Have the unit serviced by an authorized service center.

All service, other than the maintenance procedures described in this manual, should be performed by an authorized service center.

Follow all maintenance instructions in this manual.

Before inspecting, servicing, cleaning, storing, transporting or replacing any parts on the unit:

1. Stop the engine. Make sure the stop switch is in the STOP position and the throttle control trigger is released.
2. Make sure all moving parts have stopped.
3. Allow the unit to cool.
4. Make sure the chain brake is disengaged.

Never remove, modify or make inoperative any safety device furnished with the unit.

For safer, more effective performance, make sure the guide bar and chain are properly cleaned, lubricated, tightened and sharpened. Check the guide bar and chain at frequent intervals for proper adjustment.

Frequently inspect the unit for damage. Before further use, any damaged part should be carefully checked to determine that it will operate properly and perform its intended function. Check for alignment of moving parts, binding of moving parts, breakage of parts, fuel leaks and any other conditions that may affect its operation. Damaged parts should be properly repaired or replaced by an authorized service center, unless otherwise indicated in this manual.

Use only original manufacturer replacement parts and accessories,

which are designed specifically to enhance the performance and maximize the safe operation of the product... failure to do so may cause poor performance and possible injury. Use only the chain and guide bar supplied with this product be sure to secure the unit while transporting. Always use the scabbard on the guide bar and saw chain during transportation and storage.

When not in use, store the unit in a locked-up and dry, or high and dry, place to prevent unauthorized use or damage. Keep out of the reach of children. Keep the handles dry, clean and free from debris, oil, fuel and grease. Clean the unit after each use. Never douse or spray the unit with water or any other liquid. Do not use solvents or strong detergents.

KNOW YOUR PRODUCT

This unit may be used for the purposes listed below:

Basic limbing, felling and woodcutting

Removing buttress roots

ACCESSORIES

1. GASOLINE CHAIN SAW-4635
2. BAR
3. CHAIN
4. GUIDE BAR
5. RASPER
6. SCREW DRIVER
7. MEASURING OIL BOTTLE

ORERATION INSTRUCTION

■ ADDING BAR AND CHAIN LUBRICANT

The guide bar and saw chain require lubrication to minimize friction. Never starve the guide bar and chain of lubricating oil. Running the unit

without enough oil will decrease cutting efficiency, shorten the life of the saw chain, cause rapid dulling of the saw chain and excessive wear to the guide bar from overheating. An insufficient amount of lubricating oil is evidenced by smoke, guide bar discoloration or pitch build-up.

Fill the bar lube reservoir each time the fuel tank is filled. Only use bar and chain oil that is formulated to perform over a wide range of temperatures with no diluting required in the bar lube reservoir. Do not use motor oil or any other petroleum-based oil.

1. Remove the bar lube reservoir cap (Fig. 4)
2. Carefully pour the bar and chain oil into the bar lube reservoir.
3. Replace the bar lube reservoir cap and tighten securely.
4. Wipe off excess oil.

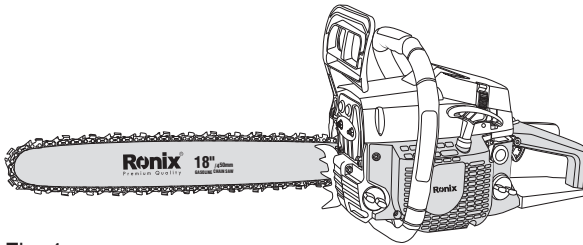

Fig. 4

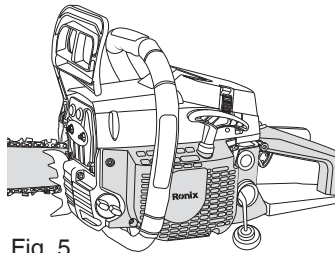

Fig. 5

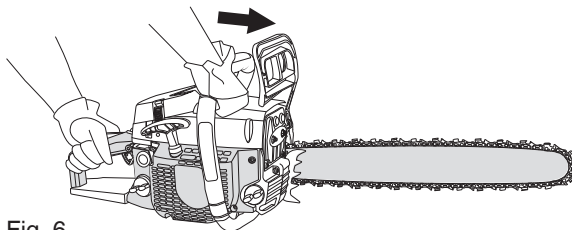

Fig. 6

FUELING THE ENGINE

This unit is designed to operate on a mixture of unleaded gasoline and 2-cycle engine oil. Refer to Oil and Fuel Information for complete mixing instructions and detailed fuel requirements.

NOTE: Always clean the fuel tank cap and surrounding area before fueling the unit. Use a damp cloth. This helps prevent debris from entering the fuel tank.

1. Turn the unit on its side so that the fuel tank is facing up (Fig. 5).
2. Slowly unscrew and remove the fuel tank cap by turning it anti-clockwise.
3. Slowly pour the proper fuel/oil mixture into the fuel tank until the tank is full.
4. Replace the fuel tank cap and turn it clockwise to secure it tightly.
5. Wipe off any spilled fuel.

TESTING THE CHAIN BRAKE

Always test the chain brake before using the unit and periodically during operation. follow these instructions to make sure the chain brake is working correctly:

1. Place the unit on a clear, firm and flat surface.
2. Start the unit. Refer to Starting and Stopping instructions. Be sure to maintain a proper grip. Refer to Proper Grip on Handles in the Operating Instructions section.
3. Pull the chain brake lever back to disengage the chain brake.
4. While the unit is running, squeeze the throttle control trigger to 1/3 throttle and then engage the chain brake by pushing the chain break lever forward with the left hand(Fig.6).

The Chain should stop moving abruptly. If it does, immediately release the throttle control trigger, turn off the engine and return the chain brake to the disengaged position. Refer to Starting and Stopping Instructions. If the chain does not stop when the chain brake is engaged, release the throttle control trigger, stop the engine and have the unit serviced by an authorized service center.



OIL AND FUEL INFORMATION

■ OIL AND FUEL MIXING INSTRUCTIONS

Old fuel and improperly mixed fuel are the two main reasons why the unit may not run properly. Be sure to use fresh, clean unleaded gasoline and quality synthetic 2-cycle air-cooled engine oil. Do not use automotive oil or boat oil; these oils will damage the engine.

Obtaining the Correct Fuel/Oil Mixture

Thoroughly mix the proper amount of 2-cycle engine oil with unleaded gasoline in a separate fuel container (do not mix them directly in the engine fuel tank). Use a 40:1 fuel/oil ratio. See the table for specific gas and oil mixing ratios.

	
UNLEADED GAS	2 CYCLE OIL
1 GALLON US (3.8 LITERS)	3.2 FL.OZ (95 ml)
1 LITER	25 ml

MIXING RATION – 40:1

STARTING AND STOPPING INSTRUCTION

■ STARTING THE ENGINE

1. Pull the choke lever out to the full extent (Fig. 7)
2. Fully press and release the oil feeder 5-10 times, slowly (Fig. 8). Some amount of fuel should be visible in the primer bulb. If fuel cannot be seen in the bulb, press and release the bulb until fuel is visible.
3. Place the unit on a firm, flat surface. Crouch in the starting position and hold the unit firmly, as shown (Fig. 9). Grip the front handle firmly

- with the left hand. Place the right foot through the rear handle/ boot loop.
4. With the right and, pull the starter rope rapidly until the first firing (pop) of the engine is heard (no more than 5 pulls).
 5. Push the choke lever in.
 6. Pull the starter rope rapidly until the engine starts.
 7. Immediately after the engine starts, depress the throttle control lockout. Then quickly squeeze and release the throttle control trigger. This releases the fast idle speed setting used for starting and allows the engine to return to normal idle speed.
 8. Allow the engine to warm up for 30-60 seconds.

STOPPING THE ENGINE

1. Release the throttle control trigger and allow the engine to return to idle speed.
 2. Move the stop switch up to the STOP position (Fig.10).
- NOTE: It is normal for the chain to coast to a stop once the stop switch is in the STOP position.
- NOTE: For emergency stopping, push the chain brake lever/ front hand guard forward to engage the chain brake and then move the stop switch up to the STOP position.
- NOTE: if moving the stop switch to the STOP position fails to stop the engine, pull the choke lever out to the full extent to stop the engine.

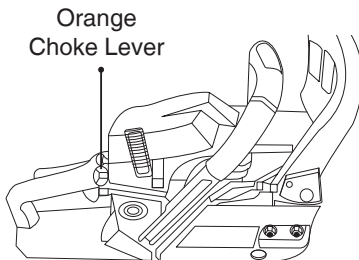

Fig. 7

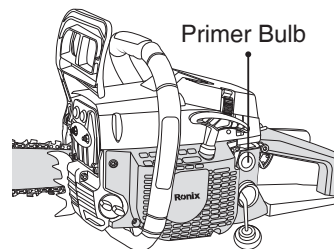

Fig. 8

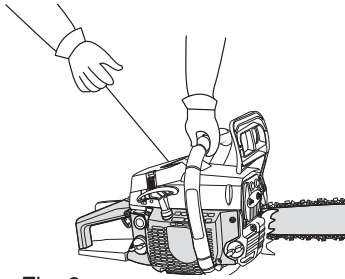

Fig. 9

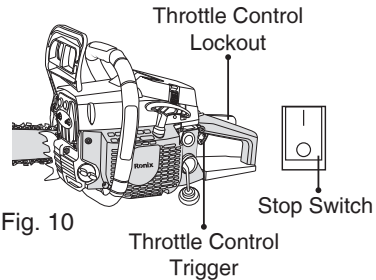

Fig. 10

PROPER GRIP ON HANDLES

- Hold the saw firmly with both hands. Always keep the left hand on the front handle and the right hand on the rear handle so that the operator's body is to the left of the

Chain line (Fig.11). use these hand placements even if the operator is left-handed.

- maintain a proper grip on the saw whenever the motor is running. The fingers should encircle the handle and the thumb should wrap under the handle (Fig 12). This grip is most likely to be broken by a kickback or other sudden reaction of the saw. Any grip in which the thumb and fingers are on the same side of the handle is dangerous because a slight kick of the saw can cause loss of control (Fig.13)

WARNING: Do not operate the throttle control trigger with the left hand while holding the front handle with the right hand. Never allow any part of your body to be in the chain line while operating a saw (Fig. 14).

- Balance body weight securely, with both feet on solid ground.
- Keep the left arm locked in a "straight arm" position to withstand any kickback force(Fig. 15).
- Keep all body parts to the left of the chain line (Fig. 15).
- Make sure the proper grip is established on the front handle and rear handle.
- Do not cut above chest height as a saw held higher is difficult to control against kickback forces.

BASIC OPERATING/CUTTING PROCEDURES

- Practice cutting a few small logs using the following technique to get the “feel” of using the saw before you begin a major sawing operation.
- Take the proper stance in front of the wood or tree to be cut.
- Start the motor and let the chain accelerate to full speed before starting the cut. Refer to Starting and Stopping Instructions.
- Begin cutting with the saw against the log.
- Keep the unit running the entire time while cutting, making sure to maintain a steady speed.
- Allow the chain to do the cutting; exert only light downward pressure. Forcing the cut could result in damage to the guide bar, chain or motor.
- Release the switch trigger as soon as the cut is completed. Allow the chain to come to a complete stop. Unnecessary wear may occur to the chain, guide bar and unit if the saw is run without a cutting load.
- Do not put pressure on the saw at the end of the cut.

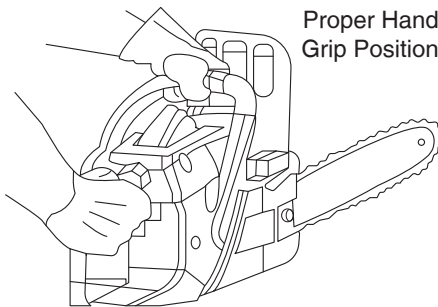

Fig. 11

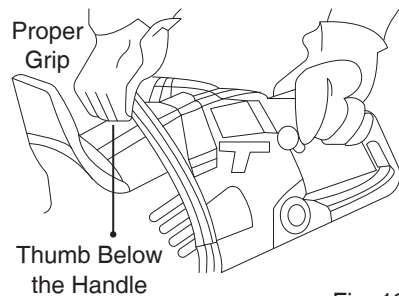

Fig. 12

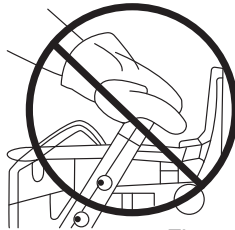
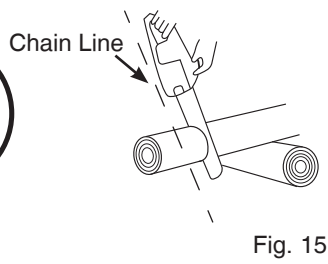
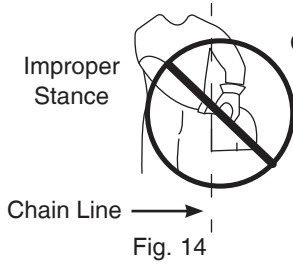

Fig. 13



WORK AREA PRECAUTIONS

- Cut only wood or materials made from wood. Do not attempt to cut sheet metal, plastics, masonry or non-wood building materials.
- Keep everyone- helpers, bystanders, children and animals – 15 m away from the cutting area. If anyone enters the work area, stop the unit! During felling operations, the safe distance should be at least twice the height of the largest trees in the felling area. During bucking operations, keep a minimum distance of 4.6 m between workers.
- Only operate the unit when visibility and light are adequate to see clearly.

REMOVING BUTTRESS ROOTS

A buttress root is a large root extending from the trunk of the tree above the ground. Remove large buttress roots prior to felling (Fig. 16).

1. Make the horizontal cut into the buttress first, followed by the vertical cut.
2. Remove the resulting loose section from the work area.
3. Remove any remaining large buttress roots.

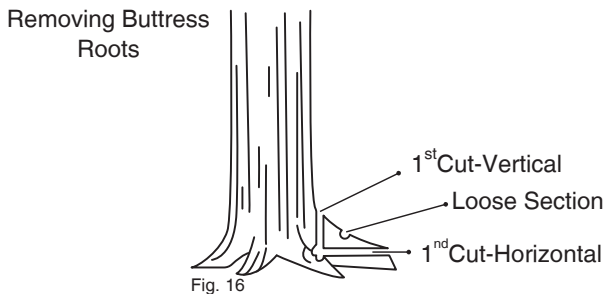

FILLING

Felling is the term for cutting down a tree. When felling a tree, it is important to heed the following warnings to reduce the risk of serious injury.

- Do not cut down trees having an extreme lean or large trees with rotten limbs, loose bark or hollow trunks. Have these trees pushed or dragged down with heavy equipment, then cut them up.
- Do not cut trees near electrical wires or buildings. Leave this operation for professionals
- Check the tree for damaged or dead branches that could fall and cause serious personal injury.
- Periodically glance at the top of the tree during the back cut to see if the tree is going to fall in the desired direction.
- If the tree starts to fall in the wrong direction, or the saw gets caught or hung up during the fall, leave the saw and evacuate the area immediately!
- When bucking and felling operations are being performed by two or more persons, at the same time, the felling operation should be separated from the bucking operation by a distance of at least twice the height of the tree being felled. Trees should not be felled in a manner that would endanger any person, strike any utility line or cause any property damage. If the tree does make contact with any utility line, the utility company should be notified immediately.

The operator should keep on the uphill side of terrain, as the tree is likely to roll or slide after it is felled.

Pick your escape route (or routes in case the intended route is blocked). Clear the immediate area around the tree and make sure there are no obstructions in your planned path of retreat. Clear the path of safe retreat approximately 135 from the planned line of fall (Fig. 17)

Consider the force and direction of the wind, the lean and balance of the tree and the location of large limbs.

These things influence the direction in which the tree will fall. Do not try to fell a tree along a line different from its natural line of fall.

Remove dirt, stones, loose bark, nails, staples and wire from the tree

where felling cuts are to be made.

Small trees, up to 15-18 cm in diameter, are usually felled in a single cut. Larger trees require a process consisting of two main cutting operations: a notched undercut followed by a felling back cut.

1. Notched Undercut. This cut determines the direction that the tree will fall. It should be made on the side of the tree facing the felling direction. Cut a notch about 1/3 the diameter of the trunk in the side of the tree. Make the notch cuts so they intersect at a right angle to the line of fall. This notch should be cleaned out to leave a straight line. To keep the weight of the wood off the saw, always make the lower cut of the notch before the upper cut.

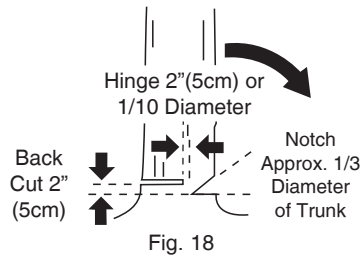
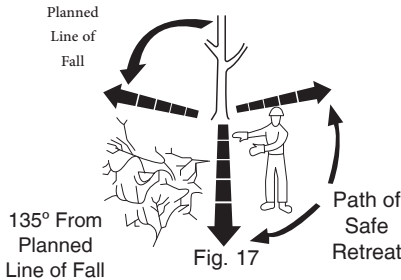

2. Felling Back Cut. This cut fells the tree. Make the back cut level and horizontal, and at a minimum of 5 cm above the horizontal cut of the notch (Fig. 18). If the diameter of the tree is greater than the length of the guide bar, make two cuts as shown (Fig. 19). When the felling cut gets close to the hinge, the tree should begin to fall (Fig. 20).

If there is any chance the tree may not fall in the desired direction or if it may rock back and bind the saw chain, stop cutting before the felling cut is complete and use wedges of wood or plastic to open the cut and drop the tree along its desired line of fall (Fig. 21).

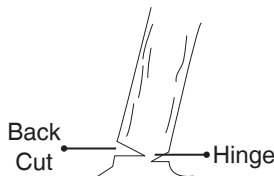
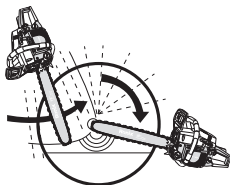

LIMBING

Limbing is the process of removing branches from a fallen tree (Fig. 22). Work slowly, while maintaining a proper grip and stance.

Leave the larger support limbs under the tree to keep the tree off the ground while cutting.

Limbs should be cut one at a time. Remove the cut limbs from the work area often to help keep the work area clean and safe.

Branches under tension should be cut from the bottom up to avoid binding the chain saw.

Keep the tree between you and the chain saw while limbing. Cut from the side of the tree opposite the branch that is being cut.

BUCKING

Bucking is the process of cutting a fallen tree into desired log lengths. Work slowly, while maintaining a proper grip and stance.

Cut only one log at a time.

Keep a clear cutting area. Make sure that no object can contact the guide bar nose and chain during cutting; this can cause kickback. Refer to Understanding kickback in the Safety Information section.

To maintain complete control of the chain saw when cutting through the log, release the cutting pressure near the end of the cut without relaxing the grip on the chain saw handles. Do not let the chain contact the ground. After completing the cut, wait for the saw chain to stop before moving the chain saw. Always stop the motor before moving from log to log.

OVERBUCKING

Begin on the top side of the log with the bottom of the saw against the log: exert light pressure downward. During overbucking, the saw will tend to pull away. Be prepared for this reaction and hold the saw firmly to maintain control. (Fig. 23)

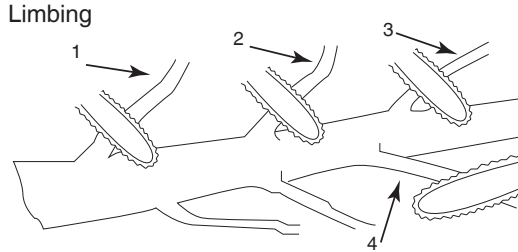

Cut Limbs One at a Time and Leave Support
Limbs Under the Tree Until the Log is Cut

Fig. 22

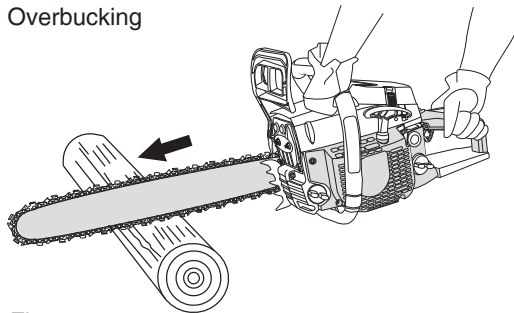

Fig. 23

UNDERBUCKING

Begin on the under side of the log with the top of the saw against the log; exert light pressure upward. During underbucking, the saw will tend to push back. Be prepared for this reaction and hold the saw firmly to maintain control. (Fig. 24)

Bucking Logs Under Stress

Make the first bucking cut 1/3 of the way through the log and finish with a 2/3 cut on the opposite side. The log will tend to bend as it is being cut. The saw may become pinched or hung in the log if the first cut is deeper than 1/3 of the diameter of the log. Give special attention to logs under stress to prevent the guide bar and chain from pinching.

1. When the log is supported on one end (Fig. 25): First, cut from the bottom (underbuck) 1/3 of the way through the log to avoid splintering. Second, cut from above (overbuck) to meet the first cut and avoid pinching.
2. When the log is supported on both ends (Fig. 26): First, overbuck 1/3 of the way through the log to avoid splintering. Second, underbuck to meet the first cut and avoid pinching.

Underbuckling

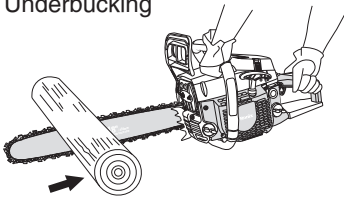

Fig. 24

Log Supported at One End

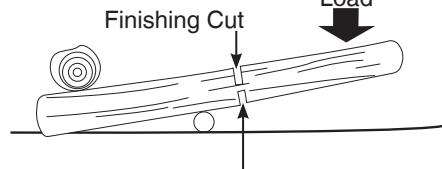

Fig. 25 Firs Cut - 1/3 Diameter

Log Supported at Both Ends

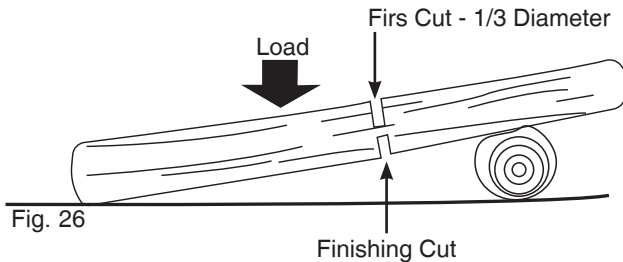

Fig. 26

BUCKING FULLY SUPPORTED LOGS

When the log is supported along the entire length, cut from the top (overbuck), being careful to avoid cutting into the ground (Fig. 27).

Bucking on a Slope

When bucking on a slope, always stand on the uphill side of the log (Fig. 28).

Bucking with a wedge

If the wood diameter is large enough to insert a soft wooden or plastic bucking wedge without touching the chain, one should be used to hold the cut open to prevent pinching. (Fig. 29)

PRUNING

Pruning is the process of trimming limbs from a live tree. (Fig. 30).

Work slowly, while maintaining a proper grip and stance.

Do not cut from a ladder; this is extremely dangerous. Leave this operation for professionals.

Do not cut above chest height, as a saw held higher is difficult to control during kickback.

When pruning trees, it is important not to make the finishing cut next to the main limb or trunk until the limb is cut further out to reduce the weight. This prevents stripping the bark from the main member.

1. Underbuck the branch 1/3 through for the first cut.
2. The second cut should overbuck to drop the branch off.
3. Make the finishing cut smoothly and neatly against the main member so the bark will grow back to seal the wound.

CUTTING SPRINGPOLES

A springpole is any log, branch, rooted stump, or sapling that is bent under tension by other wood so that it springs back if the wood holding it is cut or removed (Fig. 31). On a fallen tree, a rooted stump has a high potential of springing back to the upright position during the bucking cut to separate the log from the stump.

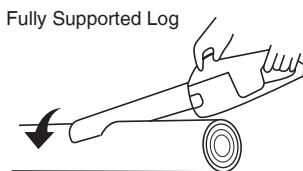

Fig. 27

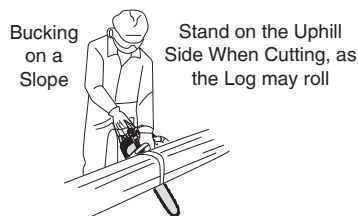

Fig. 28

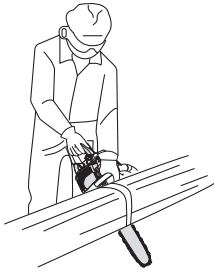

Fig. 29

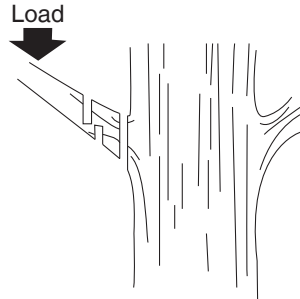

Fig. 30

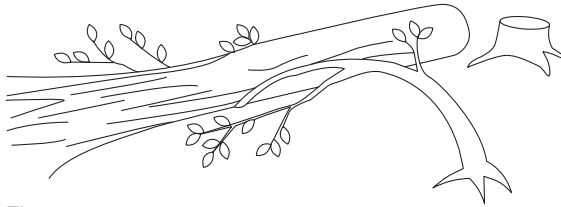

Fig. 31

ADJUSTING THE CHAIN TENSION

The chain must be tensioned whenever the flats on the drive links hang out of the bar groove (Fig. 32). Check for proper chain tension before starting the unit and periodically during operation.

NOTE: A new chain tends to stretch. Check the chain tension frequently and tighten as required.

1. Stop the engine, wait for all moving parts to stop, allow the unit to cool, disconnect the spark plug wire and disengage the chain brake.
2. Slightly loosen the bar-retaining nuts (Fig. 33).
3. Hold the guide bar tip up and rotate the chain-tensioning screw (Fig. 34) Clockwise with a standard screwdriver to tension the chain. The desired tension depends on the temperature of the chain:

Cold Chain Tensioning – A cold chain is correctly tensioned when there is no sag on the underside of the guide bar and the chain seats snugly against the guide bar with the drive links in the bar groove.

Warm Chain tensioning – During normal operation, the temperature of

the chain will increase. The drive links of a correctly tensioned warm chain will hang approximately 1.3 mm out of the bar groove (Fig. 35).

4. Once adjusted, lift the tip of the guide bar up to check for proper tension (Fig. 36). If the chain is still too loose, release the tip of the guide bar and turn the chain-tensioning screw $\frac{1}{2}$ turn clockwise. Repeat this process until the desired tension is achieved.

NOTE: if the chain is too tight, it will not rotate. To loosen the chain, turn the chain-tensioning screw $\frac{1}{4}$ turn counterclockwise. Ensure that the chain can be turned by hand without binding (Fig. 37). Also note the chain will not rotate if the chain brake is engaged.

5. Hold the tip of the guide bar up and securely tighten the bar-retaining nuts.

REMOVING/REPLACING THE GUIDE BAR AND CHAIN

Use only a low-kickback saw chain that has met kickback performance per ANSI B 175.1 for this saw. This fast-cutting chain provides kickback reduction when properly maintained.

NOTE: When replacing the guide bar and chain, use only manufacturer suggested replacement parts. The use of any other parts may create a hazard or cause product damage and will VOID the warranty.

Removing the Guide Bar and Chain

1. Make sure the engine is off and the spark plug wire is disconnected.
2. Make sure the chain brake is disengaged by pulling the chain brake lever/ front hand guard back, toward the front handle, as far as possible.
3. Remove the bar-retaining nuts with the supplied multi-purpose tool (Fig. 33)
4. Remove the guide bar cover by pulling it straight out.

NOTE: Turning the chain-tensioning screw $\frac{1}{2}$ -1 turn counterclockwise will loosen the chain and make its removal easier.

5. Push the guide bar back as far as it will go against the drive sprocket.
6. Remove the chain from the guide bar, starting at the tip and finishing by removing the chain from around the drive sprocket.
7. Remove the guide bar from the mounting surface.

Installing the Guide Bar and Chain

1. Fit the guide bar flush against the mounting surface so that the two guide bar bolts are in the guide bar slot (Fig. 33). Push the guide bar back as far as it will go against the drive sprocket.

2. Lay out the saw chain in a loop and straighten any kinks.

3. Place the chain over the drive sprocket and into the groove of the guide bar (Fig. 39). Begin at the top of the guide bar.

NOTE: Make sure the chain is correctly installed and the cutters are facing in the correct direction. The cutters on the top of the guide bar should face toward the guide bar tip in the direction of chain rotation (Fig. 38). If they face backward, turn the loop over.

NOTE: Make sure the chain – tensioning pin is in the chain – tensioning pin hole (Fig 40).

4. Replace the guide bar cover and bar-retaining nuts. Tighten the bar-retaining nuts hand tight.

NOTE: Do not over-tighten the bar retaining nuts. The guide bar should still be free to move for chain tension adjustment.

5. Adjust the chain tension. Refer to the adjusting the Chain Tension instruction above.

6. Hold the tip of the guide bar up and securely tighten the bar- retaining

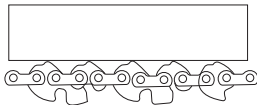

Fig. 32

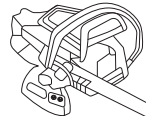

Fig. 33

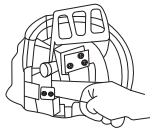

Fig. 34

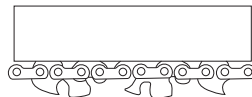

Fig. 35

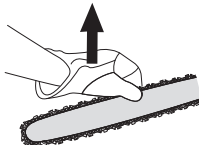

Fig. 36

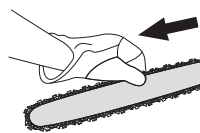

Fig. 37

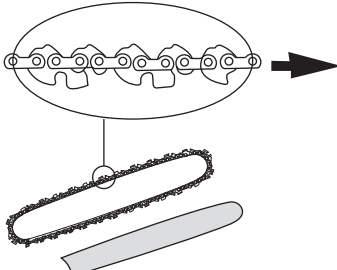

Fig. 38

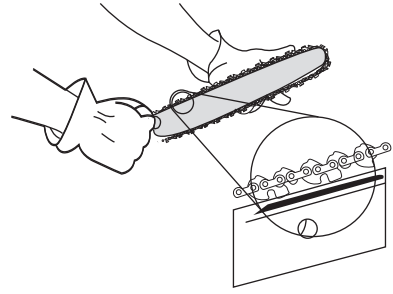

Fig. 39

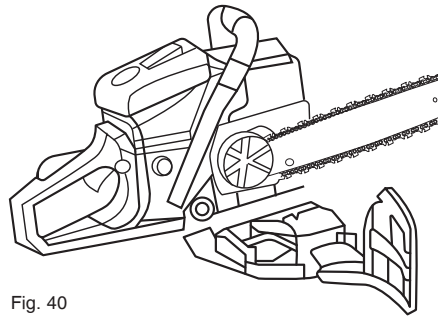

Fig. 40

CLEANING AND STORAGE

1. Stop the engine and wait for all moving parts to stop.
2. Allow the unit to cool.
3. Slacken the chain if it was retensioned at operating temperature during cutting work. The chain contracts as it cools down. If it is not slackened, it may damage the crank shaft and bearings.
4. Wipe the unit down with a damp cloth. Do not douse the unit with water. Do not use solvents or strong detergents. If preparing the unit for long-term storage (three months or more), remove the chain and guide bar, then clean the unit thoroughly with a damp cloth a firm – bristled, non-wire, brush can be used to remove debris from the bar groove and assembly. When finished, reassemble the until. Refer to removing/ Replacing the Guide Bar and Chain.
5. Debris must be removed from the cylinder fins on a regular basis to

reduce the risk of damage to the unit and personal injury from fire. Use compressed air, at 40 PSI or lower, to blow debris from the cylinder fins (Fig. 41).

Always wear safety goggles/glasses when cleaning the cylinder fins with compressed air. Use a small wire brush to dislodge stubborn debris. Do not use water or solvents on the cylinder fins. If there is a significant amount of debris that remains after cleaning, have the cylinder fins cleaned by an authorized service dealer.

6. Spray the guide bar and chain with corrosion inhibiting oil.

STORAGE INSTRUCTIONS

NOTE: It is normal for oil to seep from the unit when it is not in use. Please take this into consideration when storing the unit.

Follow the cleaning instructions listed above

2. Attach the scabbard to the guide bar and chain.

3. Store the unit in a dry, high and/or locked location, out of the reach of children and other unauthorized persons. Always store the unit and fuel in a cool, well-ventilated space where fuel vapors cannot reach sparks or open flames from water heaters, electric motors or switches, furnaces, etc. Never store the unit, with fuel in the tank, inside a building where fumes may reach an open flame or spark.

Long-term storage instructions

In addition to the standard storage instructions described above, perform the following steps when storing the unit for 30 days or more:

1. Drain the fuel tank by running the unit dry. Alternatively, tip the engine housing/fuel tank over to pour the fuel mixture into a suitable container and then run the engine until it stops in order to remove fuel from the carburetor.

2. Allow the engine to cool.

3. Remove the spark plug. Refer to inspecting/ Adjusting/Replacing the spark plug.

4. Pour 1 teaspoon of clean 2-cycle oil into the combustion chamber (Fig. 42). Pull the starter rope slowly several times to coat the internal components.

5. Replace the spark plug.

REMOVING A UNIT FROM LONG-TERM STORAGE

1. Remove the spark plug.
2. Pull the starter rope briskly to clear excess oil from the combustion chamber.
3. Clean and gap, or replace, the spark plug.
4. Prepare the unit for operation.

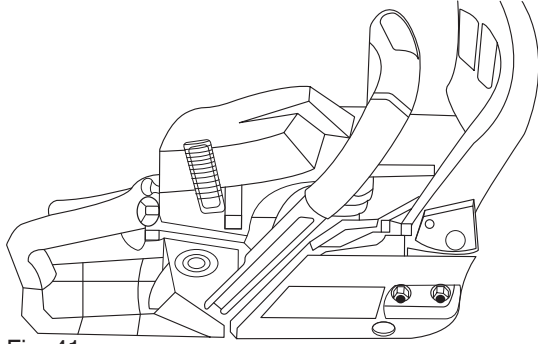

Fig. 41

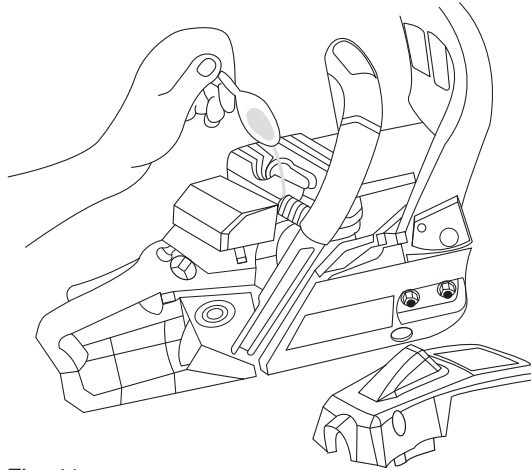

Fig. 41

TROUBLE SHOOTING

THE UNIT WILL NOT START OR STARTS BUT DOES NOT CONTINUE TO RUN	
CAUSE	SOLUTION
The unit started incorrectly	Follow all starting and Stopping Instructions
The carburetor mixture adjustment setting incorrect	Have the carburetor adjustment by an authorized service center
The spark plug is fouled	Clean, gap or replace the spark plug
The fuel tank is empty	Fill the fuel tank with properly mixe fuel
The primer bulb was not pressed enough	Press the primer bulb fully and slowly 10 times
THE UNIT STARTS, BUT THE ENGINE HAS LOW POWER	
CAUSE	SOLUTION
The fuel filter is plugged	Have the fuel filter cleaned or replaced by an authorized service center
The choke lever is in the wrong position	Move the choke lever to Position 3
The spark arrestor screen is dirty	Replace the spark arrestor screen
The air filter is dirty	Replace the air filter
The carburetor mixture adjustment setting is incorrect	Have the carburetor adjusted by an authorized service center
THE ENGINE HESITATE	
CAUSE	SOLUTION
The carburetor mixture adjustment setting is incorrect	Have the carburetor adjusted by an authorized service center
The fuel is old and/or improperly mixed	Drain the fuel tank and add fresh, properly mixed fuel
The air filter is plugged	Replace the air filter
The spark plug is foule	Clean, gap or replace the spark plug
THE ENGINE RUNS ERRATICALL	
CAUSE	SOLUTION
The spark plug is incorrectly gapped	Clean, gap or replace the spark plug
The spark arrestor screen is plugged	Replace the spark arrestor screen
The air filter is dirty	Replace the air filter
THE ENGINE SMOKES EXCESSIVELY	
CAUSE	SOLUTION
The carburetor mixture adjustment is incorrect	Have the carburetor adjusted by an authorized service center

The fuel mixture is incorrect	Drain the fuel tank and fresh, properly mixed fuel
THERE IS NO POWER WHEN THE UNIT IS UNDER LOAD	
CAUSE	SOLUTION
The carburetor mixture adjustment setting is incorrect	Have the carburetor adjusted by an authorized service center
The fuel is old and/or improperly mixed	Drain the fuel tank and fresh, properly mixed fuel
The air filter is plugged	Replace the air filter
The spark plug is fouled	Clean, gap or replace the spark plug
THE CHAIN BAR AND CHAIN ARE RUNNING HOT AND SMOKING OR STUCK	
CAUSE	SOLUTION
The chain tension is too tight	Adjust the chain tension
The bar lube reservoir is empty	Refill the bar lube reservoir
The guide bar groove and/or oil passages are dirty	Clean the guide bar groove and oil passages
The oil flow from the automatic oiler is too low	Increase the oil flow from the automatic oiler
THE CHAIN DOES NOT ROTATE WHILE THE ENGINE IS RUNNING	
CAUSE	SOLUTION
The chain tension is too tight	Adjust the chain tension
The guide bar and chain are assembled incorrectly	Refer to Removing/Replacing the Guide Bar and Chain
The guide bar and chain are damaged	Inspect the guide bar and chain for damage
The chain brake is engaged	Disengage the chain brake
THE CHAIN ROTATES, BUT DOES NOT CUT	
CAUSE	SOLUTION
The chain is dull	Sharpen the chain
The chain is on backwards	Reverse the direction of the chain

Ronix[®]
Premium Quality