

Ronix[®]

Premium Quality

GASOLINE CHAIN SAW 4645PRO

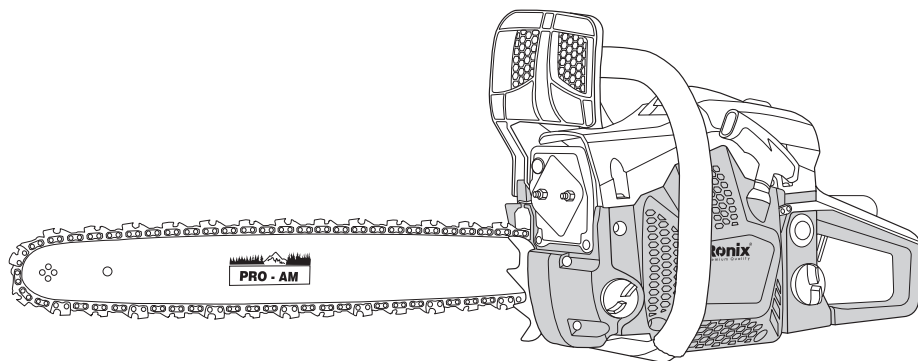

TECHNICAL SPECIFICATION

Model	4552B
Power Source	Gasoline
Engine Type	2-Stroke
Engine Power	1.5KW
Cutting Capacity	"Brush cutter: 255mm Grass trimmer: 430mm"
Ignition	CDI
Two-cycle Oil/Gasoline Mixing Ratio	1:35
Shaft Type	Flexible Shaft
Working Pole Diameter	26mm
Displacement	51.7cc
Fuel Capacity	1000ml
Idling Speed Range	3100 ±400 R/MIN
Weight	5.1kg
Spplied in	Ronix color box
Includes	3T metal blade, Nylon trimming head, Guard, Shoulder harness, Mixing oil bottle, Hex key

PART LIST

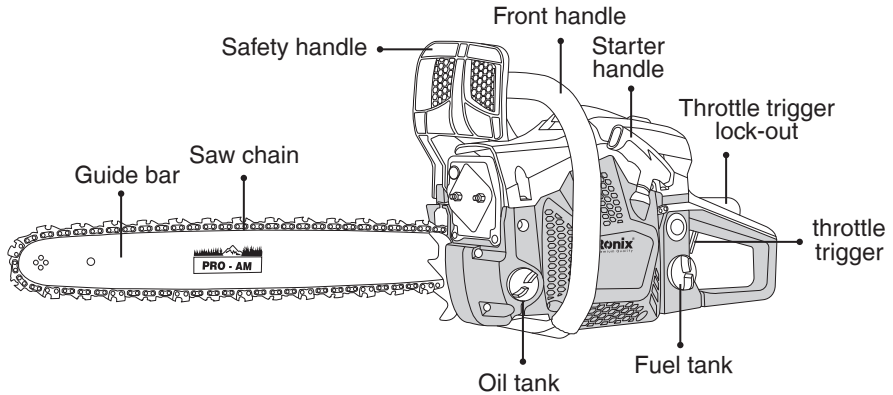

⚠ WARNING!

Before using our products, please read this manual carefully to understand the proper use of your unit.

SAFETY FIRST

Instructions contained in warnings within this manual marked with symbol. concern critical points which must be taken into consideration to prevent possible serious bodily injury, and for this reason you are requested to read all such instructions carefully and follow them without fail.

WARNINGS IN THE MANUAL

⚠ WARNING!

This mark indicates instructions which must be followed in order to prevent accidents which could lead to serious bodily injury or death.

■ IMPORTANT

This mark indicates instructions which must be followed, or it leads to mechanical failure, breakdown, or damage.

▲ NOTE

This mark indicates hints or directions useful in the use of the product.

■ CONTENTS

- Attention! Read these notes before you start working with the saw and keep them.

Read the instructions carefully. Familiarize with the control elements so that you are able to safely operate the device. Always keep these Operating Instructions together with the chain saw.

▲ ATTENTION!

Risk of hearing defects.

Under normal operating conditions, this device can expose the operator to a noise level of 80 dB (or more).

The chain-saw shall be held with the right hand on the rear handle and the left hand on the front handle.

▲ ATTENTION!

Noise protection! Please observe the local regulations when operating your device.

- Intended/ not intended use

The chain saw seves trunks, square timbers and for cutting branches, according to the available cutting length. Only materials from wood may be worked on.

Sufficient personal protection equipment (PPE) is required according to the operating instructions during the use. This product is designed for use by a trained operator for fruning and dismantling standing tree crowns. For damage or injuries which resulting from misapplication are responsible by the user/operator and not the manufacturer. Suitable sawing chains, guide bars combinations may be used as mentioned in the operating instructions only for the machine. A component of the intended use is also the attention of the safety references, as well as the operating instructions in the operating instructions. Persons, who

serve the machine, must make themselves trained and familiar with this product and think over all the possible dangers. Beyond that the valid rules for the prevention of accidents are to be kept in every detail. Other general rules within ranges according to industrial medicine and in terms of safety are to be considered. Changes in the machine completely exclude a support of the manufacturer and from it developing damage and lead to expiring the warranty. This equipment is designed for use in home garden.

ATTENTION!

Remainder driven

Also when appropriate using the tool always remains a certain residual risk, which









Cannot be excluded. From the kind and construction of the tool the following potential endangerments can be derived:

- contact with the unprotected sawing chain (cuts)
- Unexpected, sudden movement of the sawing sword (cuts)
- Damage of the ears, if no prescribed protection of the ears is carried
- Inhale from poisonous particle, exhaust gases of the combustion engine.
- Contact of gasoline on the skin
- Noise. A degree of noise from the machine is not avoidable. Route noisy work is to be licensed and limits for certain periods. Keep rest periods and they may need to restruct the working hours to a minimum. For their personal protection and protection of hours to a minimum. For their personal protection and protection of people working nearby, an appropriate hearing protection shall be worn;
- Vibration. Warning: The actual existing vibration emission value during use of the machine can deviate from the manual or the manufacturer specified. This can be caused by the following factors, before or during each of use should be considered:
 - If the machine is used correctly
 - If the method of cutting the material and how it is processed correctly.
 - The use of the machine state is in the regulatory

- Sharpness condition of cutting tool or cutting tool real
- The grab handles are mounted back to optional vibration handles and are they fixed to the machine body.

If you notice an unpleasant sensation or skin discoloration during use of the machine on your hands once you stop working. Place an adequate work breaks. In disregard of adequate work breaks, there may be a hand-arm vibration syndrome.

SYMBOLS ON THE MACHINE

-  1) Read, understand and follow all warnings.
-  2) Warning! Danger of kickback. Beware of chain saw kickback and avoid contact with bar tip.
-  3) Do not use chain saw one-handed.
-  4) Always use chain saw two-handed.
-  5) Appropriate ear, eye, and head protection must be worn
-  6) Read operator's instruction book before operating this machine.
-  7) Always wear safety and anti-vibration (AV) gloves when operating the device.
-  8) Always wear safety and slip-resistant boots when operating the device.

For safe operation and maintenance, symbols are carved in relief on the machine. According to these indications, please be careful not to make any mistake.

 a) The port to refuel the “MIX GASOLINE” Position. Near the fuel cap

 b) The port to refuel the chain oil Position: near the oil cap

STOP c) Operate the engine switch Flipping the switch to the “O” position,

immediately the engine stops.

Position: rear at the left side of the rear handle

PULL d) Operate the choke knob Pull out the choke knob, close the

choke; push in the choke knob, open the choke. Position: rear at the right side of the rear handle.

 e) Adjust the oil pump

if you turn the rod by screwdriver follow the arrow to the “MAX” position, the chain oil flow more, and if you turn to the “MIN” position, less.

Position: Bottom of the power unit

H
L f) The screw under the “H” stamp is The High-speed mixture
T

adjustment screw.

The screw under the “L” stamp is the Slow-speed mixture adjustment screw.

The screw up the “T” stamp is the idle speed adjustment screw. Position: upper-left of the rear handle

 g) Shows the directions that the chain brake is released (white

arrow) and activated (black arrow).

Position: Front of the chain cover

 h) Shows the direction of the saw chain installation.

Position: Front of the chain cover



i) Guaranteed sound power level for this equipment.



J) Engine manual start.



k) Decompression valve (if applicable) Push in the decompression

valve button to open the valve.

FOR SAFE OPERATION

■ BEFORE OPERATE THE PRODUCT

- 1) Before using our products, please read this manual carefully to understand the proper use of your unit.
- 2) Never operate a chain saw when you are fatigued, ill, or upset, or under the influence of medication that may make you drowsy, or if you are under the influence of alcohol or drugs.
- 3) Operate the chain saw only in well ventilated areas. Never start or run the engine inside a closed room or building. Exhaust fumes contain dangerous carbon monoxide.
- 4) Never cut in high wind, bad weather, when visibility is poor or in very high or low temperatures. Always check the tree for dead branches which could fall during the felling operation.
- 5) Use safety and slip-resistant footwear, snug fitting clothing and eye, hearing and head protection devices. Use the anti-vibration (AV) glove. It is believed that a condition called Raynaud's phenomenon, which affects the fingers of certain individuals, may be brought about by exposure to vibration and cold. Loss of color and numbness in the fingers. The following precautions are strongly recommended because the minimum exposure which might trigger the ailment is unknown.

Keep your body warm, especially the head, neck, feet, ankles, hands and wrists. Maintain good blood circulation by performing vigorous arm exercises during frequent work breaks and also by not smoking. Keep the saw chain sharp and the saw, including the AV system, well maintained. A dull chain will increase cutting time, and pressing a dull chain through wood will increase the vibrations transmitted to your hands. A saw with loose components or with damaged or worn AV buffers will also tend to have higher vibration levels. Limit the hours of operation.

All the above mentioned precautions do not guarantee that you will not sustain white finger disease or carpal tunnel syndrome. Therefore, continual and regular users should monitor closely the condition of their hands fingers.

If any of the above symptoms appear, seek medical advice immediately.

6) Always use caution when handling fuel. Wipe up all spills and then move the chain saw at least ten (10) feet (three (3) m) from the fueling point before starting the engine.

7) Eliminate all sources of sparks or flame (e.g. smoking, open flames, or work that can cause sparks) in the areas where fuel is mixed, poured, or stored. Do not smoke while handling fuel or while operating the chain saw.

8) Do not allow other persons to be near the chain saw when starting the engine or cutting a wood. Keep bystanders and animals out of the work area. Children, pets, and bystanders should be a minimum of 30feet (10m) away when you start or operate the chain saw.

9) Never start cutting until you have a clear work area, secure footing, and planned retreat path from the falling tree.

10) Always hold the chain saw firmly with both hands when the engine is running. Use a firm grip with thumb and fingers encircling the chain saw handles.

11) Keep all parts of your body away from the saw chain when the engine is running. Before you start the engine, make sure the saw chain is not contacting anything.

12) Always carry the chain saw with the engine stopped the guide bar and saw chain to the rear, and the muffler away from your body.

13) Always inspect the chain saw before each use for worn, loose, or changed parts. Never operate a chain saw that is damaged, improperly adjusted, or is not completely and securely assembled.

Be sure that the saw chain stops moving when the throttle control trigger is released.

14) All chain saw service, other than the items listed in the Operator's manual, should be performed by competent chain saw service personnel. (e.g., if improper tools are used to remove the flywheel, or if an improper tool is used to hold the flywheel in order to remove the clutch, structural damage to the flywheel could occur which could subsequently cause the flywheel to disintegrate).

15) Always shut off the engine before setting it down.

16) Use extreme caution when cutting small size brush and saplings because slender material may catch the saw chain and be whipped toward you or pull you off balance.

17) When cutting a limb that is under tension, be alert for spring back so that you will not be struck when the tension in the wood fibers is released.

18) Keep the handles dry, clean and free of oil or fuel mixture.

19) Guard against kickback. Kickback is the upward motion of the guide bar which occurs when the saw chain at the nose of the guide bar contacts an object. Kickback can lead to dangerous loss of control of the chain saw.

20) When transporting your chain saw, make sure the appropriate guide bar scabbard is in place. Securely place the machine during transport to prevent loss of fuel, damage or injury.

■ KICKBACK SAFETY PRECAUTIONS FOR CHAIN SAW USERS

WARNING!



Kickback may occur when the nose or tip of the guide bar touches an object, or when the wood closes in and pinches the saw chain in the cut. Tip contact in some cases may cause a lightning fast reverse reaction, kicking the guide bar up and back towards the operator. Pinching the saw chain along the top of the guide bar may push the guide bar rapidly back towards the operator. Either of these reactions may cause you to lose Control of the saw which could result in serious personal injury.

- Do not rely exclusively on the safety devices built into your saw. As a chain saw user you should take several steps to keep cutting jobs free from accident or injury.

1) With a basic understanding of kickback you can reduce or eliminate the element of surprise. Sudden surprise contributes to accidents.



2) Keep a good grip on the saw with both hands, the right hand on the rear handle, and the left hand on the front handle, when the engine is running. Use a firm grip with thumbs and fingers encircling the chain saw handles. A firm grip will help you reduce kickback and maintain control of the saw. Don't let go.

3) Make certain that the area in which you're cutting is free from obstructions. Do not let the nose of the guide bar contact a log, branch, or any other obstruction which could be hit while you are operating the saw.

4) Cut at high engine speeds.

5) Do not overreach or cut above shoulder height.

6) Follow manufactures sharpening and maintenance instructions for saw chain.

7) Only use replacement bars and chains specified by the manufacturer or the equivalent.

INSTALLING GUIDE BAR AND SAW CHIAN

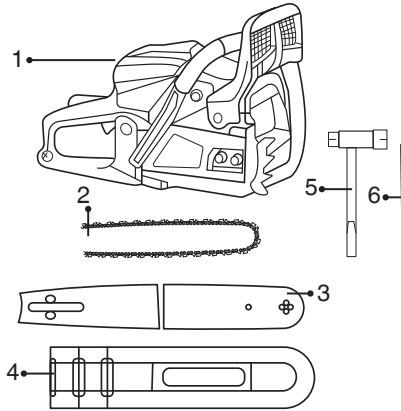

A standard saw unit package contains the items as shown below.

- (1) Power unit
- (2) Saw chain
- (3) Guide bar
- (4) Guide bar scabbard
- (5) Plug wrench
- (6) File

OPEN THE BOX AND INSTALL THE GUIDE BAR AND THE SAW CHAIN ON THE POWER UNIT AS FOLLOWS

⚠ WARNING!

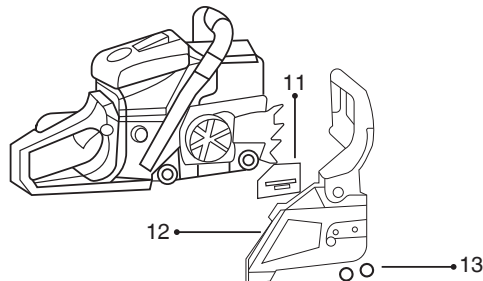

The saw chain has very sharp edges. Use protective gloves for safety.

1) Pull the guard towards the front handle to check that the chain brake is not on.

2) Loosen two nuts (13) and remove the chain cover (12) and spacer (11).

3) Gear the chain to the sprocket and, while fitting the saw chain around the guide bar, mount the guide bar to the power unit. Fit the chain tensioner nut (8) into the lower hole (7) of the guide bar, then install the chain cover, and fasten the mounting nut to finger tightness. Make sure the pin (9) on the clutch cover has inserted in the hole

(1) on the crankcase

(7) Hole

(8) Chain tensioner nut

(9) Clutch cover

(10) Hole

(11) Spacer

(12) Clutch cover

(13) Nuts

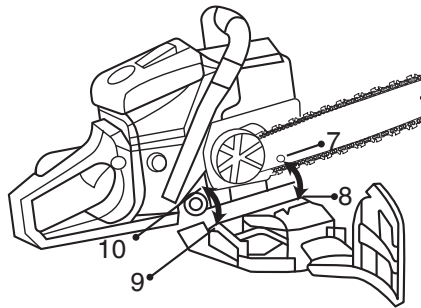

▲ NOTE

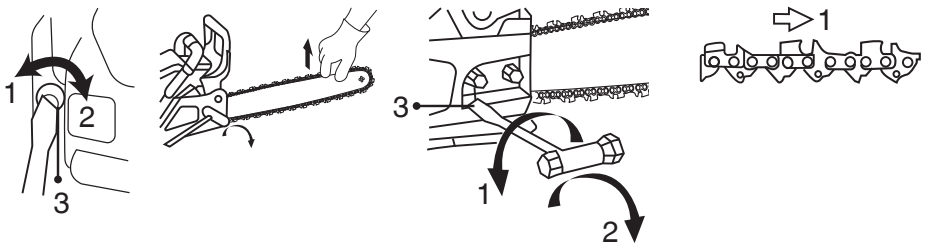

Pay attention to the correct direction of the saw chain.

(1) moving direction

4) Mount the guide bar then fit the saw chain around the bar and sprocket.

5) Fit the chain tensioner nut into the lower hole of the guide bar, then install the chain cover, and fasten the mounting nut to finger tightness.

6) While holding up the tip of the bar, adjust the chain tension by turning the tensioner screw until the tie straps just touch the bottom side of the bar rail.

7) Tighten the nuts securely with the bar tip held up (15~12 Nm). Then check the chain for smooth rotation and proper tension while moving it by hand. If necessary, readjust with the chain cover loose.

8) Tighten the tensioner screw.

(1) Loosen

(2) Tighten

(3) Chain tension adjusting screw

IMPORTANT

It is very important to maintain the proper chain tension. Rapid wear of the guide bar or the chain coming off easily can be caused by improper tension. Especially when using a new chain, take good care of it since it should expand when first used.

The Spiked bumper belongs to the chain saw. It must be screwed up on chain saw before the initial use. Please fix the spiked bumper with two screws on the forefront of the chain saw.

FUEL AND CHAIN OIL

■ FUEL



The engines are lubricated by oil specially formulated for air-cooled -2cycle gasoline engine use. If oil is not available, use an antioxidant added quality oil expressly labeled for air-cooled -2cycle engine use.

RECOMMENDED MIXING RATIO

■ GASOLINE 40: OIL 1

These engines are certified to operate on unleaded gasoline.



⚠ WARNING!

The fuel is highly flammable. Do not smoke or bring any flame or sparks near fuel.

IMPORTANT

1) FUEL WITH NO OIL (RAW GASOLINE)

- It will cause severe damage to the engine inner parts very quickly.

2) OIL FOR -4CYCLE ENGINE USE or WATER COOLED 2-CYCLE ENGINE USE

- It can cause spark plug fouling, exhaust port blocking, or piston ring sticking.

HOW TO MIX FUEL

1. Measure out the quantities of gasoline and oil to be mixed.
2. Put some of the gasoline into a clean, approved fuel container.
3. Pour in all of the oil and agitate well.

4. Pour in the rest of gasoline and agitate again for at least one minute.
5. Put a clear indication on the outside of the container to avoid mixing up with gasoline or other containers.

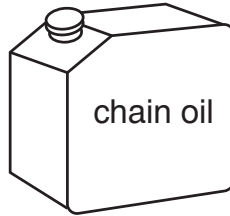

CHAIN OIL

Use special chain saw oil all year round.

NOTE

Do not use waste or regenerated oil that can cause damage to the oil pump.

OPERATION

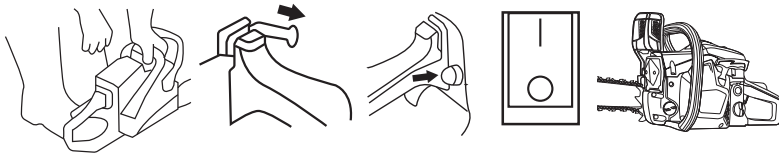

■ STARTING ENGINE

1. Untwist and remove the fuel cap and oil cap. Rest two caps on a dustless place.
2. Put fuel and oil into the fuel tank and the oil tank to %80 of the full capacity.
3. Fasten two caps securely and wipe up any fuel spillage around the unit.
4. Put the switch to the “I” position.
5. Continuously push the priming bulb until fuel comes in the bulb.

- (1) Oil
- (2) Fuel
- (3) Engine switch

(4) Choke knob

(5) Primer bulb

6. Pull out the choke knob. The choke will close and the throttle lever will then be set in the starting position.

▲ NOTE

When restarting immediately after stopping the engine. Set choke in the open position. Once the choke knob has been pulled out, it will not return to the running position even if you press the throttle trigger or press down on knob with your finger. When you wish to return the choke knob to the running position, press the throttle trigger instead.

7. Push the front handle guard down toward the front to activate the chain brake.

8. Push in the decompression valve button. (If applicable)

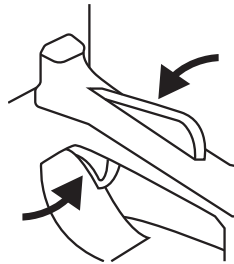

▲ NOTE

When firing occurs, the decompression valve will return to the close position automatically, you should push in the decompression valve button before each starting.

9) While holding the saw unit securely on the ground, pull the starter rope vigorously.

10) When firing occur, press the throttle trigger to allow the choke return to the running position and pull the starter handle again to start the engine.

11) Pull up the front handle guard toward the front handle to release brake. Then, allow the engine to warm up with the trigger pulled slightly.

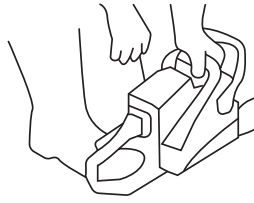

⚠ WARNING!

Before you start the engine, make sure the saw chain is not contacting anything. Make sure the chain brake always is activated before each starting.

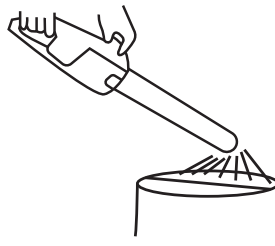

CHECKING OIL SUPPLY

After starting the engine, run the chain at medium speed and see if chain oil is scattered off as shown in the figure. Chain oil

The chain oil flow can be changed by inserting a screwdriver in the hole on bottom of the clutch side. Adjust according to your work conditions. Chain oil flow adjusting shaft.

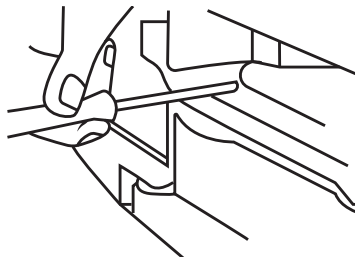

Turn the shaft counter-clockwise- Flow rich

Turn the shaft clockwise – Flow lean

IMPORTANT

The oil tank should become nearly empty by the Operation Time fuel is used up. Be sure to refill the oil tank every time when refueling the saw.

■CHECKING FUNCTIONAL OF THE CLUTCH

Before each use, you shall confirm that there is no chain movement when the chain saw running at idling speed.

■ADJUSTING CARBURETTOR

The carburetor on your unit has been factory adjusted, but may require fine tuning due to change in operating conditions. If the carburetor needs to be adjusted, contact your dealer. Before adjusting the carburetor, make sure that Provided are clean air/fuel filters and fresh, properly mixed fuel.

When adjusting, take the following steps:

IMPORTANT

Be sure to adjust the carburetor with the bar chain attached.

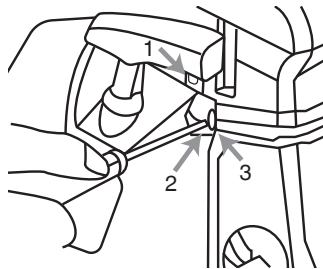

- 1) H and L needles are restricted within the number of turn as shown below.
H needle – 4/1 L needle – 4/1
- 2) Start engine and allow it to warm up in low speed for a few minutes.
- 3) Turn idle adjusting screw (T) counter – clockwise so that saw chain

does not turn. If idling speed is too slow, turn the screw clockwise.

4) Make a test cut adjust H needle for best cutting power, not for maximum speed.

(1) Idle adjusting screw (2) L needle

(3) H needle

■ CHAIN BRAKE

The chain brake is a device which stops the chain instantaneously if the chain saw recoils due to kickback.

(1) Front handle (2) Release (3) Brake (4) Front handle guard
Operation
Normally, the brake is activated automatically by inertial force. It can also be activated manually by pushing the brake lever (Front handle guard) down toward the front.

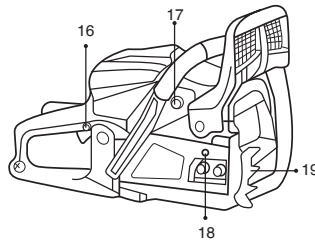

When the brake operates, a white cone pops up from the base of the brake lever.

To release brake, pull up the front handle guard toward the front handle till “click” sound is heard.

⚠ WARNING!

When the brake operates, release the throttle lever to slow down the engine speed. Continuous operation with the brake engaged will generate heat from the clutch and may cause trouble.

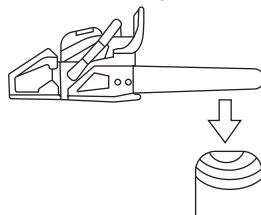

Be sure to confirm brake operation on the daily inspection.

How to confirm

- 1) Turn off the engine.
- 2) Holding the chain saw horizontally, release your hand from the front handle, hit the tip of the guide bar to a stump or a piece of wood, and confirm brake operation. Operating level varies by bar size.

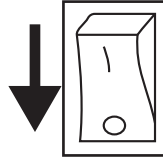

In case the brake is not effective, ask our dealer inspection and repairing.
Stopping engine idling for a few minutes.

2. Move the switch lever downward.

(1) Engine switch

SAWING

WARNING!

Before proceeding to your job, read “For Safe Operation” section it is recommended to first practice sawing easy logs. This also helps you get accustomed to your unit.

Always follow all the safety regulations which can restrict the use of the machine. The chain saw must only be used for cutting wood. It is forbidden to cut other types of material. Vibrations and kickback vary with different materials and the requirements of the safety regulations would not be respected. Do not use the chain saw as a lever for lifting, moving or splitting objects. Do not lock it over fixed stands. It is forbidden to hitch tools or applications to the P.T.O. that are not specified by the manufacturer.

It is not necessary to force the saw into the cut. Apply only light pressure while running the engine at full throttle.

It is recommended that daily inspection before use and after dropping or

other impacts to identify significant damage or defects.

Racing the engine with the chain seized in a cutaway can damage the clutch system. When the saw chain is caught in the cut, do not attempt to pull it out by force, but use a wedge or a lever to open the cut.

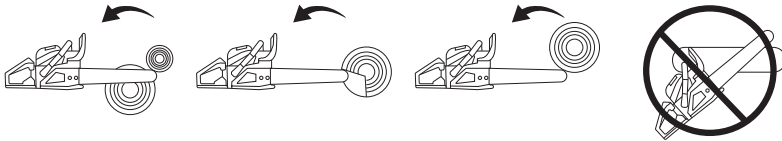

■ GUARD AGAINST KICKBACK

This saw is also equipped with a chain brake that will stop the chain in the event of kickback if operating properly. You must check the chain brake operation before each usage by running the saw at full throttle.

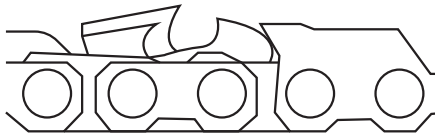

For 1 or 2 seconds and pushing the front hand guard forward. The chain should stop immediately with the engine at full speed. If the chain is slow to stop or does not stop then replace the brake band and clutch drum before use.

It is extremely important that the chain brake be checked for proper operation before each use and that the chain is sharp in order to maintain the kickback safety level of this saw. Removal of the safety devices, inadequate maintenance, or incorrect replacement of the bar or chain may increase the risk of serious personal injury due to kickback.

- Felling a tree

1. Decide the felling direction considering the wind, lean of the tree, location of heavy branches, ease of job after felling, and other factors.
2. While clearing the area around the tree, arrange a good foothold and retreat path.
3. Make a notch cut one-third of the way into the tree on the felling side.
4. Make a felling cut from the opposite side of the notch and at a level slightly higher than the bottom of the notch.

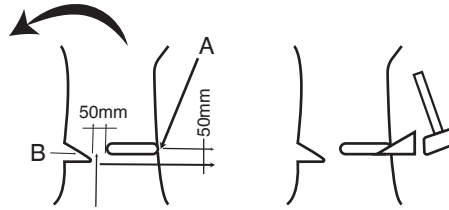

When you cut a tree, be sure to warn your neighboring workers of the danger.

(A) Notch cuts

(B) Felling cut

■ LOGGING AND LIMBING

⚠ WARNING!

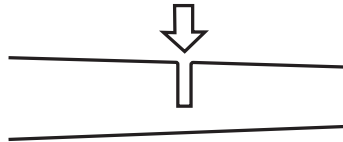

1. Always ensure your foothold as well as stability of the tree.
2. Be alert to the rolling over of a cut log.
3. Read the instructions in “For Safe Operation” to avoid kickback of the saw. Before starting work, check the direction of bending force inside the log to be cut.

Always finish cutting from the opposite side of bending direction to prevent the guide bar from being caught in the cutaway.

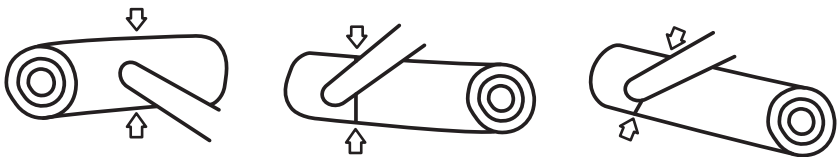

■ CUTTING A NOT PILLOWED LOG

Saw down halfway, then roll the log over and cut from the opposite side.

■ CUTTING A PILLOWED LOG

In the area a in the picture right above, saw up from the bottom one-third and finish by sawing down from the top. In the area B, saw down from the top – one-third and finish by sawing up from the bottom.

■ TO LIMB A FELLED TREE

First check which way the limb is bent. Then make a shallow cut into the compressed side to prevent the limb from being torn. Cut through from the tensed side.

⚠ WARNING!

Be alert to the spring back of a cut limb.

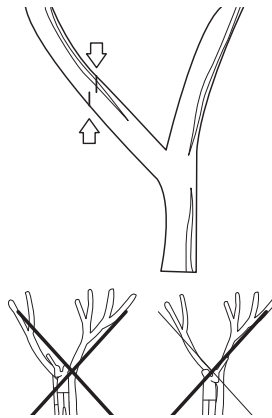

■ PRUNING

Cut up from the bottom, finish down from the top

⚠ WARNING!

1. Do not use an unstable foothold or a stepladder.
2. Do not overreach.
3. Do not cut above shoulder height.
4. Always use both hands to grip the saw.

⚠ WARNING!

The spiked bumper must always be put on while using the chain saw on tree trunk. Push the spiked bumper into the tree trunk by using the rear handle. Push the front handle in the direction of cutting line. The spiked bumper must be remaining set for further saw guiding if necessary. Use a spiked bumper when cutting trees and thick branches can ensure your safety and decrease the working strength and vibration level.

If there's barrier between the cutting material and chainsaw, turn off the machine. Wait until it stops completely. Wear the safety glove and remove the barrier. If the chain must be removed, please follow the instruction of relevant part like installation in manual. A trial run must be conducted after the cleaning and newly installation. If vibration or mechanical noise is discovered, please stop the use and contact your dealer.

MAINTENANCE

⚠ WARNING!

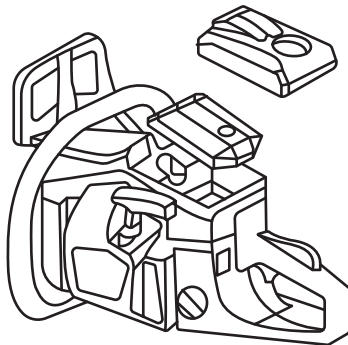

Before cleaning, inspecting or repairing your unit, make sure that engine has stopped and is cool. Disconnect the spark plug to prevent accidental starting.

Follow the instructions to carry out regular maintenance, pre-operating procedures and daily maintenance routines. Improper maintenance may result in serious damage to the machine.

■ MAINTENANCE AFTER EACH USE

1) Air filter

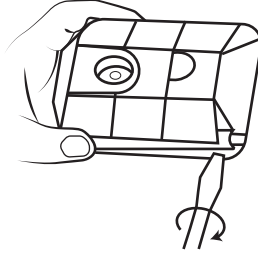

Dust on the cleaner surface can be removed by tapping a corner of the cleaner against a hard surface. To clean dirt in the meshes, split the cleaner into halves and brush in gasoline. When using compressed air, blow from the inside.

To assemble the cleaner halves, press the rim until it clicks.

2) Oiling port

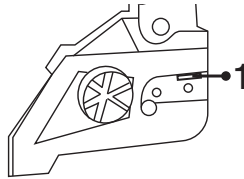

Dismount the guide bar and check the oiling port for clogging.

(1) Oiling port

3) Guide bar

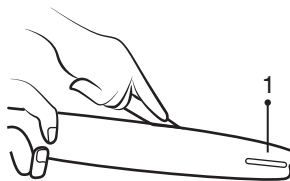

When the guide bar is dismantled, remove sawdust in the bar groove and the oiling port. Grease the nose sprocket from the feeding port on the tip of the bar.

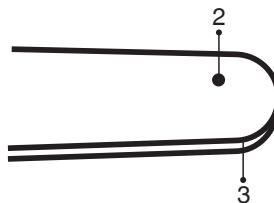

- (1) Oiling port
- (2) Grease port
- (3) Sprocket

4) Others

Check for fuel leakage and loose fastenings and damage to major parts, especially handle joints and guide bar mounting. If any defects are found, make sure to have them repaired before operating again.

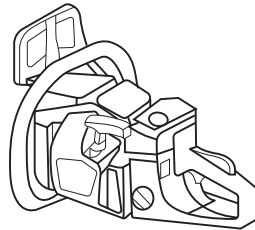

■ PERIODICAL SERVICE POINT

1) Cylinder fins

Dust clogging between the cylinder fins will cause overheating of the engine. Periodically check and clean the cylinder fins after removing the air cleaner and the cylinder cover. When installing the cylinder cover, make sure that switch wires and grommets are positioned correctly in place.

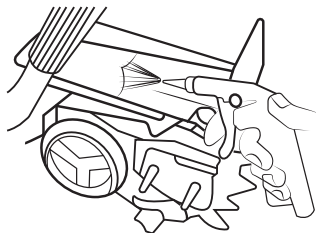

2) Fuel filter

- (a) Using a wire hook, take out the filter from the filler port.

(1) Fuel filter

(b) Disassemble the filter and wash with gasoline, or replace with a new one if needed.



IMPORTANT

- After removing the filter, use a pinch to hold the end of the suction pipe.
- When assembling the filter, take care not to Allow filter fibers or dust inside the suction pipe.

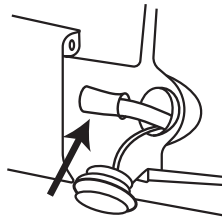

3) Oil tank

With a wire hook, take out the oil filter through the filler port and clean in gasoline. When putting the filter back into the tank, make sure that it comes to the front right corner. Also clean off dirt in the tank. (2) Oil filter

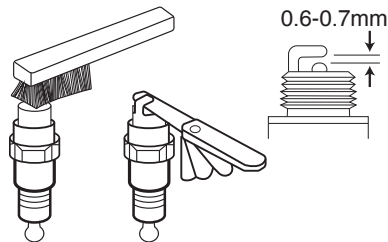

4) Spark plug

Clean the electrodes with a wire brush and reset the gap to 0.65mm an

necessary.

Spark plug type NHSP LD L8RTF or CHAMPION RCJ7Y or NGK BPMR7A
5) Sprocket

Check for cracks and for excessive wear interfering with the chain drive. If the wearing is found obviously, replace it with a new one. Never fit a new chain on a worn sprocket, or a worn chain on a new sprocket.

- (1) Sprocket
- (2) Clutch drum
- (3) Needle bearing
- (4) Washer
- (5) Clutch block

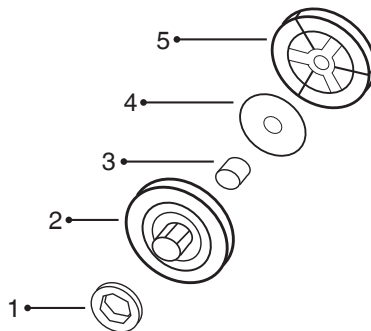

6) Front and Rear dampers

Replace if adhered part is peeled or crack is observed on the rubber part.

7) Decompression valve (if applicable)

After extended period of use decompression valve may not close or come out due to the Maintenance

Built up carbon inside of the valve mounting hole in cylinder. To remove the carbon, take the following steps:

a) Remove air cleaner cover, cylinder cover, spark plug and decompression valve from the engine

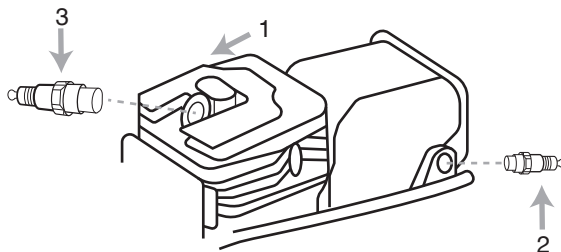

- 1) cylinder
 - 2) Decompression valve
 - 3) Spark plug
 - 4) Clean the electrodes with a wire brush. Viewing through the spark plug hole, crank down the piston to the lowest position by pulling recoil starter slowly.
 - c) Prepare diameter 2.3-4mm drill bit.
 - d) Lay down the engine facing the valve mounting hole downward so that the removed carbon will not drop into cylinder.
 - e) Insert the drill bit into the hole turning slowly so that the bit will scrape off the built up carbon.
 - f) Make sure to remove the drill bit and pull recoil starter several times. Reinstall the disassembled parts.
- Use only the spare parts which named in this manual. Using the other spare part can cause serious injury.

MAINTENANCE OF SAW CHAIN AND GUIDE BAR

■ SAW CHAIN

WARNING!

It is very important for smooth and safe operation to keep the cutters always sharp.

Your cutters need to be sharpened when:

- Sawdust becomes powder-like.
- You need extra force to saw in.
- The cut way does not go straight.
- Vibration increases.
- Fuel consumption increases.



CUTTER SETTING STANDARDS

WARNING!

Be sure to wear safety gloves.

- Before filing
- Make sure the saw chain is held securely.
- Make sure the engine is stopped.
- Use a round file of proper size for your chain.

Chain type:

4645PRO: Oregon 21BPX

File size: 4.8mm

Place your file on the cutter and push straight forward.

Keep the file position as illustrated.

After every cutter has been set, check the depth gauge and file it to the proper level as illustrated.

WARNING!

Be sure to round off the front edge to reduce the chance of kickback or tie-strap breakage.

Make sure every cutter has the same length and edge angles as illustrated.

GUIDE BAR

- Reverse the bar occasionally to prevent partial wear.
- The bar rail should always be a square. Check for wear of the bar rail. Apply a ruler to the bar and the outside of a cutter. If a gap is observed between them, the rail is normal. Otherwise, the bar rail is worn. Such a bar needs to be corrected or replaced.

(1) Ruler

(2) Gap

(3) No gap

(4) Chain tilts

⚠ WARNING!

The table contains a list of all possible combinations between bar and chain, indicating those which may be used on each machine, marked with the symbol

FOR REPLACEMENT

Pitch	Guide bar			Chain	ain saw model
Zoll	Length inches/cm	Groove width inches/mm	Code	Code	4645PRO
0.325"	45"/18cm	1.5"/0.058mm	Oregon 188PXBK095	Oregon 21BPX072X	

For replacement use only above bars and chains. If you use non-approved combinations it may cause serious personal injury and damage to the machine.

STORAGE

- 1) Empty the fuel tank and run the engine out of fuel.
- 2) Empty the oil tank.
- 3) Clean the entire unit.
- 4) Store the unit in a dry place out of the reach of children.

WASTE DISPOSAL AND ENVIRONMENTAL PROTECTION

Never pour remainders of chain lubricant or 2-stroke fuel mixture in the drain or sewerage system or soil, but dispose of the in a proper, environmentally friendly way, e.g., at a special collecting point or dump. If your devices should become useless somewhere in the future or you do not need it any longer, do not dispose of the device together with your domestic refuse, but dispose of it in an environmentally friendly way, e.g., at a special collecting point or dump.

If your devices should become useless somewhere in the future of you do not need it any longer, do not dispose of the device together with your

domestic refuse, but dispose of it in an environmentally friendly manner. Thoroughly empty the oil/lubricant and fuel tanks and dispose of the remainders at a special collecting point or dump. Please also dispose of the device itself at an according collecting/recycling point. By doing so, plastic and metal parts can be separated and recycled. Information concerning the disposal of materials and devices are available from your local administration.

TROUBLESHOOTING GUIDE

PROBLEM	CAUSE	REMEDY
1) Starting failure	Check fuel for water Or substandard mixture	Replace with proper fuel
	Check for engine flooding.	Remove and dry the spark plug.
	Check spark ignition.	Then pull the starter again with no choke.
2) Lack of power/Poor acceleration / Rough idling	Check fuel for water or substandard mixture.	Replace with proper fuel.
	Check air filter and fuel filter for clogging.	Clean.
	Check carburetor for inadequate adjustment.	Readjust speed needles.
3) Oil does not come out	Check oil for substandard quality.	Replace.
	Check oil passage and ports for clogging.	Clean.

If the unit seems to need further service, please consult with an authorized service shop in your area.

Ronix[®]
Premium Quality

www-ronixtools-com