

# Ronix<sup>®</sup>

Premium Quality

## HVLP ELECTRIC SPRAY GUN 1395

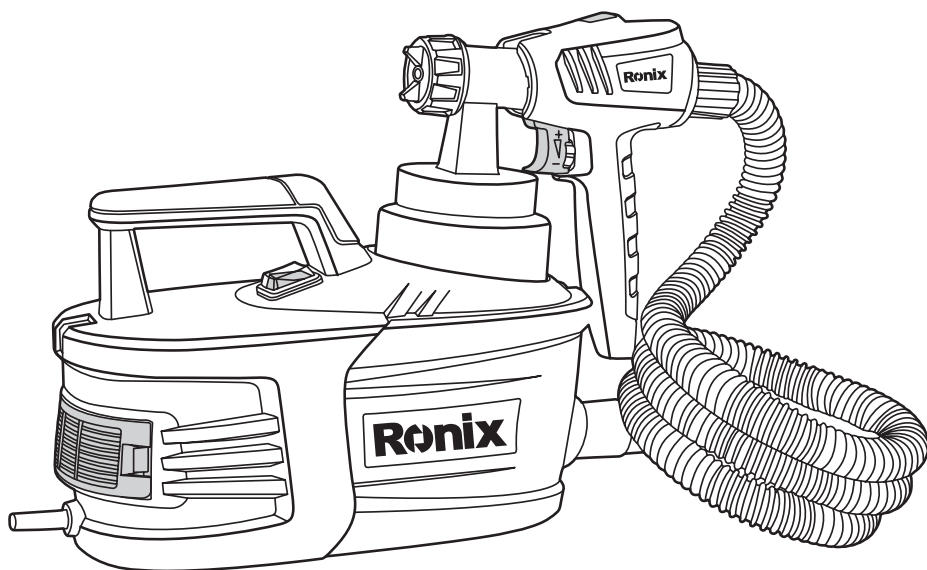

## SPECIFICATIONS

Model	1395
Voltage	220-240V
Power	950W
Frequency	50-60Hz
Max. Flow	1000 ml/min
Nozzle	Φ1.8mm, Φ2.6mm
Max. Viscosity	100 din/sec
Painting System	HVLP
Paint Reservoir	800ml
Supplied In	Ronix Color box
Weight	3.2kg
Includes	1pc Viscosity measuring cup, 1pc nozzle, 1pc Connect tube, 1pc Shoulder strap

## PARTS LIST

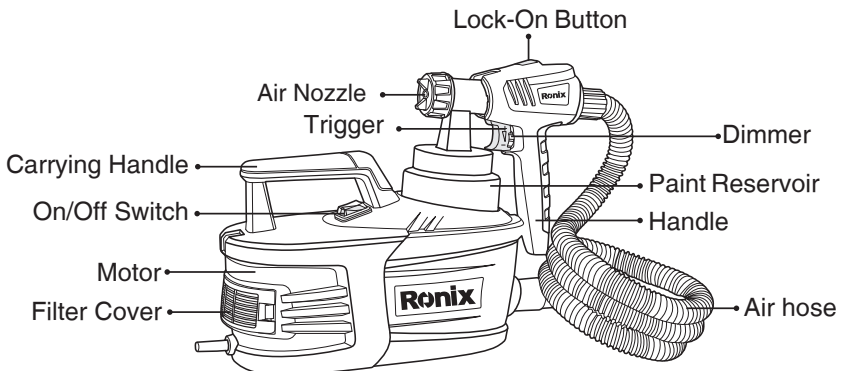

The declared vibration total value has been measured in accordance with a standard test method and may be used for comparing one tool with another.

The declared vibration total value may also be used in a preliminary assessment of exposure.

**⚠ WARNING!**

The vibration emission during actual use of the power tool can differ from the declared total value depending on the ways in which the tool is used. There is the need to identify safety measures to protect the operator that are based on an estimation of exposure in the actual conditions of use (taking account of all parts of the operating cycle such as the times when the tool is switched off and when it is running idle in addition to the trigger time).

**⚠ WARNING!**

When using electric tools, basic safety precautions, including the following, should always be followed to reduce the risk of fire, electric shock and personal injury.

Read all these instructions before operating this product and save these instructions.

## **FOR SAFE OPERATIONS**

### **■ WORK AREA**

- a) Keep work area clean and well lit. Cluttered and dark areas invite accidents.
- b) Consider work area environment. Do not expose power tools to rain. Do not use power tools in damp or wet locations. Keep work area well lit. Do not use power tools where there is risk to cause fire or explosion.
- c) Do not operate power tools in explosive atmospheres, such as in the presence of flammable liquids, gasses or dust. Power tools create

sparks which may ignite the dust of fumes.

c) Keep children away. Do not let visitors touch the tool or extension cord. All visitors should be kept away from area.

## ■ ELECTRICAL SAFETY

a. Power tool plugs must match the outlet. Never modify the plug in any way. Do not use any adapter plugs which earthed (grounded) power tools. Unmodified plugs and matching outlets will reduce risk of electric shock.

b) Guard against electric shock. Avoid body contact with earthed or grounded surfaces such as pipes, radiators, ranges and refrigerators. There is an increased risk of electric shock if your body is earthed or grounded.

c) Do not expose power tools to rain or wet conditions. Water entering a power tool will increase the risk of electric shock.

d) Do not abuse the cord. Never use the cord for carrying, pulling or unplugging the power tool. Keep cord away from heat, oil, sharp edges or moving parts. Damaged or entangled cords increase the risk of electric shock.

e) When operating a power tool outdoors, use an extension cord suitable for outdoor use. Use of a cord suitable for outdoor use reduces the risk of electric shock. Always use tool in conjunction with a residual circuit breaker device.

## ■ PERSONAL SAFETY

a) Stay alert, watch what you are doing and use common sense when operating a power tool.

Do not use a power tool while you are tired or under the influence of drugs, alcohol or medication.

A moment of inattention while operating power tools may result in serious personal injury.

b) Use safety equipment. Always wear eye protection. Safety equipment such as dust mask, non-skid safety shoes, hard hat,

or hearing protection used for appropriate conditions will reduce personal injuries.

c) Avoid accidental starting. Ensure the switch is in the off position before plugging in. Carrying power tools with your finger on the switch or plugging in power tools that have the switch on invites accidents.

d) Remove any adjusting key or wrench before turning the power tool on. A wrench or a key left attached to a rotating part of the power tool may result in personal injury.

e) Do not overreach. Keep proper footing and balance at all times. This enables better control of the power tool in unexpected situations.

f) Dress properly. Do not wear loose clothing or jewellery, they can be caught in moving parts. Rubber gloves and nonskid footwear are recommended when working outdoors. Wear protecting hair covering to contain long hair.

g) If devices are provided for the connection of dust extraction and collection facilities, ensure these are connected and properly used. Use of these devices can reduce dust related hazards.

h) Use clamps or a vice to hold work. It's safer than using your hand and it frees both hands to operate tool.

## **■ POWER TOOL USE AND CARE**

a) Do not force the tool. It will do the job better and safer at the rate for which it was intended.

b) Do not use the power tool if the switch does not turn it on and off. Any power tool that cannot be controlled with the switch is dangerous and must be repaired.

c) Disconnect the plug from the power source before making any adjustments, changing accessories, or storing power tools. Such preventive safety measures reduce the risk of starting the power tool accidentally.

d) Store idle tools. When not in use, tools should be stored in a dry, high or locked up place, out of reach of children.

e) Maintain power tools. Check for misalignment or binding of moving parts, breakage of parts and any other condition that may affect the power tools operation.

If damaged, have the power tool repaired before use. Many accidents are caused by poorly maintained power tools.

f) Keep cutting tools sharp and clean. Properly maintained cutting tools with sharp cutting edges are less likely to bind and are easier to control.

g) Use the right tool. Do not force small tools or attachments to do the job of a heavy duty tool. Do not use tools for purpose not intended; for example, do not use circular saws to cut tree limbs or logs.

h) Damaged switches must be replaced at a customer service repair centre. Do not use power tools that cannot be switched on and off.

i) Do not leave power tools unattended while they are switched on. Always switch off the tool and wait until it has come to a full standstill before leaving.

j) If the mains cable has been damaged, it must be replaced with a special mains cable. These can be obtained from the manufacturer or the manufacturer's customer service department. The mains cable may only be replaced by the manufacturer, the manufacturer's customer service department or equally qualified persons.

## ■ SERVICE

a) Please use a qualified expert who uses original replacement parts to repair your power tool. This will ensure proper functioning of the power tool.

b) Caution! The use of any accessories or additional tools other than those recommended in this manual may lead to an increased risk of injury. Only use original replacement parts.

## ADDITIONAL SAFETY INSTRUCTIONS

- NEVER SPRAY AT PERSONS - Never aim the nozzle at another person or animal. Never allow the spray to come into direct contact

with the skin.

- FLASH POINT - This spray gun must not be used for spraying flammable paints and solvents with a flash point of less than 55 °C
- VENTILATION - Always make sure that there is adequate ventilation in the work area when spraying.
- BASKET NOZZLE -Always keep the spray basket nozzle in place during use.
- CONSIDER WORK AREA ENVIRONMENT -Do not use spray guns where there is a risk of fire or explosion.
- BEWARE OF ANY HAZARD -Beware of any Hazard by the material being sprayed and consult the markings on the container or the information supplied by the manufacturer.
- DO NOT SPRAY - Do not spray any material where the hazard is not known.
- USE EYE PROTECTION - Always use appropriate eye protection to keep hazardous vapors or fumes out of the eyes.
- WEAR A MASK - Never operate a spray gun without wearing a face mask.
- PROTECT YOUR EARS -Wear ear protectors if the sound pressure exceeds 85 dB(A).
- MAINTAIN YOUR TOOLS - Keep your spray gun, paint container and nozzles clean. Do not clean with flammable liquids with a flash point less than 55 °C Inspect the mains lead periodically and if damaged have it replaced by a qualified person.
- NAKED FLAMES -Never spray near a naked flame or appliance pilot flame.
- SMOKING -Never smoke whilst spraying.
- THINNING - Always read the paint manufacturers thinning recommendations or instructions before using paint or other materials.
- DISCONNECT FROM THE MAINS SUPPLY - Always disconnect from the mains supply when filling the paint container or cleaning the spray gun.

- SWITCH OFF WHEN NOT SPRAYING -Avoid running the unit with the flow rate knob fully closed for any length of time.
- If the supply cord is damaged, it must be replaced by a special cord or assembly available from the manufacturer or its service agent.

## PREPARING FOR USE

### ■ COATING MATERIALS

#### **Coating Materials Suitable for Use**

Solvent-based and water-soluble lacquer paints Mordants, glazes, impregnations, clear varnishes, synthetic enamels, coloured paints, alkyd resin varnishes, primers, radiator paints, anti-rust paints, special-effect paints, textured paints.

#### **Coating Materials Not Suitable for Use**

Materials that contain highly abrasive components, caustic solutions and acidic coating substances. Flammable materials.

### ■ MATERIAL PREPARING

Before spraying, the material being used may need to be thinned with the proper solvent as specified by the material manufacturer.

 Never exceed the thinning advice given by the coating manufacturer.

The viscosity cup attached helps measuring the viscosity of paint. Hold the test cup up and measure the time in seconds until the liquid empties out.

#### **NOTE:**

Material to be sprayed should always be strained to remove any impurities in the paint which may enter and clog the system. Impurities



in the paint will give poor performance and a poor finish.

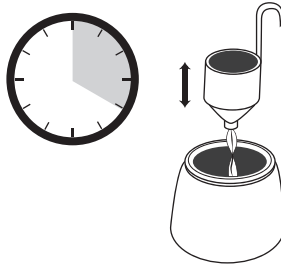

### ■ ATTACH CARRYING BELT

Attach the belt to the fixer on the main housing adjust a suitable length easy for carrying.

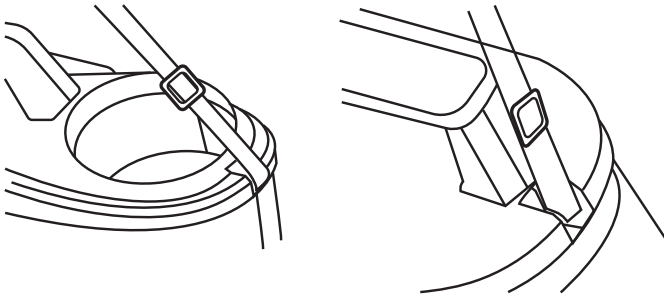

### ■ ASSEMBLE PICKUP TUBE

When spraying objects overhead, turn suction tube back, and turn clockwise to fix the container.

When spraying horizontal surfaces, turn suction tube forward, and turn clockwise to fix the container.

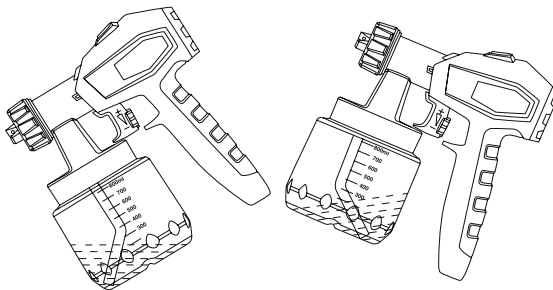

## ■ SPRAY PATTERN SETTINGS

Three different spray jet settings can be chosen on the spray gun, depending on the application and target object.

### ⚠ IMPORTANT:

The air cap only can be turned at an angle. Do not force.

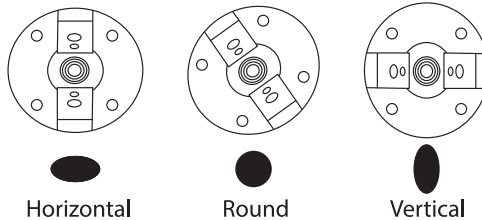

Horizontal: For large vertical surface

Round: For corner and small surface

Vertical: For large horizontal surface

### ⚠ WARNING!

Danger of injury!

Never pull the trigger while adjusting the air cap. Never toward the nozzle to your eye or skin. Test the setting on a scrap.

## USE

### ■ ATTACH HOSE COUPLER

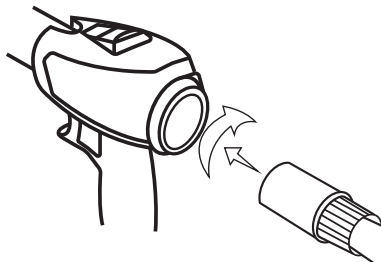

## ■ SWITCH ON

“1” switch on, “0” switch off.

## ■ SPRAY VOLUME SETTING

Reduce or increase the spray volume by turning the knob.

### ▲ NOTE:

A coarse pattern will get when setting at high volume if working with thin material. Always test the setting on scrap before applying material to the surface. Increase the spray volume if the material is high viscosity.

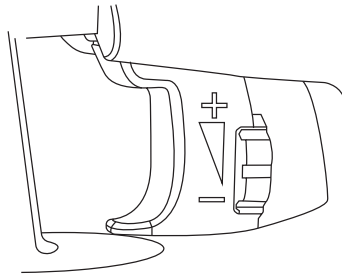

## ■ SPRAY DISTANCE AND TIPS

- Hold the paint spray gun upright and maintain a constant distance of about 10-30 cm to the object being sprayed.
- Move the paint spray gun evenly either from side to side or up and down.
- Always start and stop spraying outside the target surface.
- Clean the paint build on the nozzle and air cap.

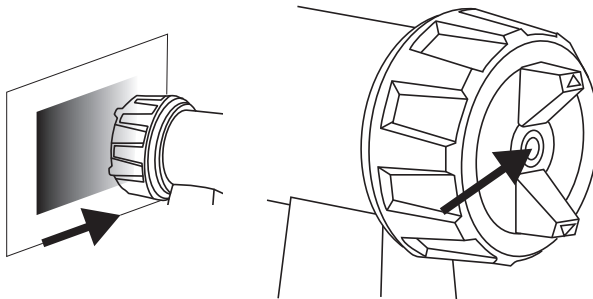

- A) Evenly move
- B) Clean the paint build on the nozzle and cap

## **AFTER USE**

- 1) Unplug the power plug. Turning open the container and pulling the trigger guard and letting the paint into the original paint container.
- 2) Divide the spray gun. Press down the unlock button downwards. Pull out the sprayer.

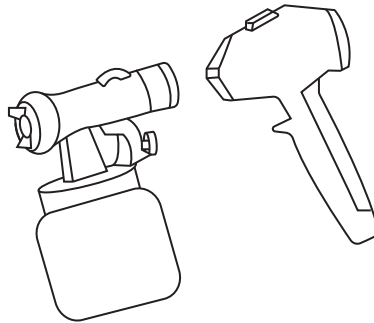

- 3) Clean the sprayer. Unscrew the container. Empty any remaining coating material back into the material tin. Use only solvents with a flashpoint over 38°C.

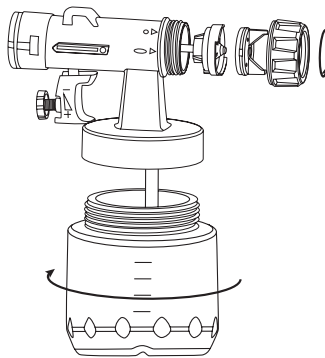

- 4) Assemble the gun again.

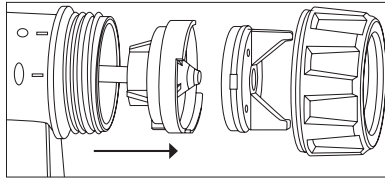

Pay attention to the rib and should be fitted in the slot.

**⚠ CAUTION:**

Never clean seals, nozzle or air holes of the spray gun with metal objects.

The seal parts are only solvent-resistant to a limited extent. Do not immerse in solvent, only wipe.

**⚠ WARNING!**

Never hold the spray gun MOTOR part under water or immerse it into liquids. Clean the housing only with a moistened cloth.

5) clean the outside of the spray gun and container with a cloth soaked in solvent or water.

## MAINTENANCE

Change the air filter if it is soiled Squeeze the clip on each side of the filter cover and pull out the cover. Replace the filter with a new one.

**⚠ WARNING!**

Never operate the machine without the air filter, dirt could be sucked in and interfere with the function of the machine.

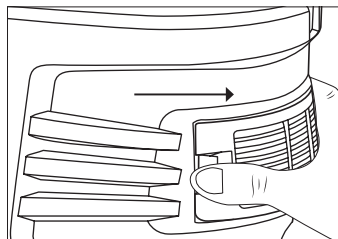

## ENVIRONMENTAL PROTECTION



The appliance and accessories should be recycled in an environmentally friendly way. Do not dispose of the appliance with household waste. Support environmental protection by taking the appliance to a local collection point or obtain information from a specialist retailer.

## CORRECTION OF MALFUNCTIONS

PROBLEM	CAUSE	REMEDY
No coating material emerges from the nozzle	Nozzle clogged Feed tube clogged Material volume setting turned too far to the downside(-) Feed tube loose No pressure build-up in container Viscosity of coating material too high	Clean Clean Turn to the upside (+) Insert Tighten container Thin the paint
Coating material drips from the nozzle	Nozzle loose Nozzle worn Coating material assembly at air cap, nozzle or needle	Tighten nozzle Change nozzle Clean
Atomization too coarse	Viscosity of coating material too high Material volume too large Nozzle contaminated Air filter heavily soiled Too little pressure build-up in container	Thin Turn material volume adjusting screw to the downside (-) Clean Change Tighten container



**Ronix**<sup>®</sup>  
Premium Quality