

Ronix[®]

Premium Quality

HEAT GUN 2000W
1105



www.ronixtools.com

TECHNICAL SPECIFICATION

Model	1105
Power	2000W
Voltage	220-240V
Frequency	50-60Hz
Working Current	8A
Body Material	PP+GF30
Operating Temperature	100° - 600°C
Noise Level	50dB-60dB
Motor type	SCRUB Brushless Motor
Air Volume & Temperature	1:150L/min 100-600°C 2:300L /min 100-600°C 3:500L/min100-600°C
Weight	0.86Kg
Heating Element Type	Ceramic Heating Element
Includes	1pc Protective cover against high temperature and scald, 1pc Fishtail surface nozzle, 1pc cone nozzle, 1pc Concentrator Nozzle, 1pc Glass Protection Nozzle

PART LIST

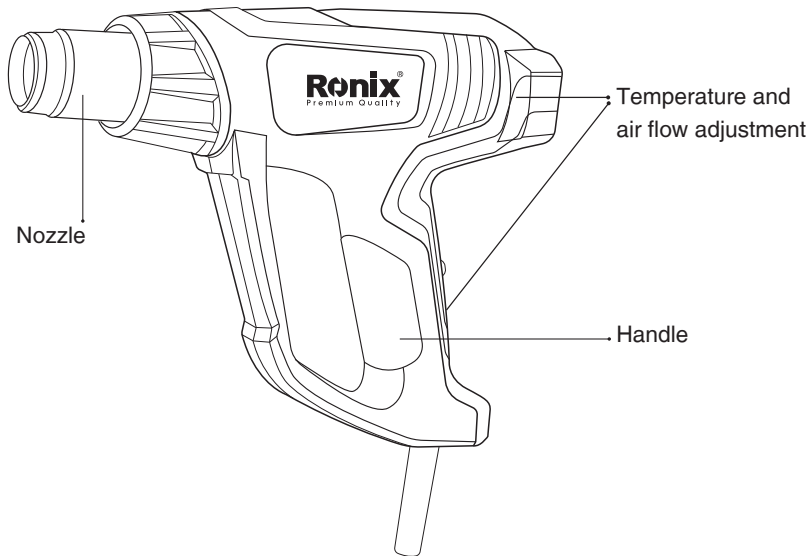

GENERAL POWER TOOL SAFETY WARNINGS

Read all safety warnings and all instructions. Failure to follow all warnings and instructions may result in electric shock, fire and/or serious injury. Save all warnings and instructions for future reference. The term “power tool” in the warnings refers to your mains operated (corded) power tool or battery operated (cordless) power tool.

■ WORK AREA

- Keep work area clean and well lit. Cluttered and dark areas invite accidents.
- Do not operate power tools in explosive atmospheres, such as in the presence of flammable liquids, gases or dust. Power tools create sparks which may ignite the dust or fumes.
- Keep children and bystanders away while operating a power tool. Distractions can cause you to lose control.

ELECTRICAL SAFETY

- Power tool plugs must match the outlet. Never modify the plug in any way. Do not use any adapter plugs with earthed (grounded) power tools. Unmodified plugs and matching outlets will reduce risk of electric shock.
- Avoid body contact with earthed or grounded surfaces such as pipes, radiators, ranges and refrigerators. There is an increased risk of electric shock if your body is earthed or grounded.
- Do not expose power tools to rain or wet conditions. Water entering a power tool will increase the risk of electric shock.
- Do not abuse the cord. Never use the cord for carrying, pulling or unplugging the power tool. Keep cord away from heat, oil, sharp edges or moving parts. Damaged or entangled cords increase the risk of electric shock.
- When operating a power tool outdoors, use an extension cord suitable for outdoor use. Use of a cord suitable for outdoor use reduces the risk of electric shock.
- If operating a power tool on a damp location is unavoidable, use a residual current device (RCD) protected supply. Use of an RCD reduces the risk of electric shock.

PERSONAL SAFETY

- Stay alert, watch what you are doing and use common sense when operating a power tool. Do not use a power tool while you are tired or under the influence of drugs, alcohol or medication. A moment of inattention while operating power tools may result in serious personal injury.
- Use safety equipment. Always wear eye protection. Safety equipment such as dust mask, non-skid safety shoes, hand hat, or hearing protection used whenever conditions require will reduce personal injuries.
- Avoid accidental starting. Ensure the switch is in the off position before plugging in.

- Carrying power tools with your finger on the switch or plugging in power tools that have the switch on invites accidents.
- Remove any adjusting key or wrench before turning the power tool on. A wrench or a key left attached to a rotating part of the power tool may result in personal injury.
- Do not overreach. Keep proper footing and balance at all times. This enables better control of the power tool in unexpected situations.
- Dress properly. Do not wear loose clothing or jewelry. Keep your hair, clothing and gloves away from moving parts. Loose clothes, jewelry or long hair can be caught in moving parts.
- If devices are provided for the connection of dust extraction and collection facilities, ensure these are connected and properly used. Use of these devices can reduce dust related hazards.

POWER TOOL USE AND CARE

- Do not force the power tool. Use the correct power tool for your application. The correct power tool will do the job better and safer at the rate of which it was designed.
- Do not use the power tool if the switch does not turn it on and off. Any power tool that cannot be controlled with the switch is dangerous and must be repaired.
- Disconnect the plug from the power source before making any adjustments, changing accessories, or storing power tools. Such preventive safety measures reduce the risk of starting the power tool accidentally.
- Store idle power tool out of the reach children and do not allow persons unfamiliar with the power tool of these instructions to operate the power tool. Power tools are dangerous in the hands of untrained users.
- Maintain power tools. Check for misalignment or sticking of moving parts, breakage of parts and other condition that may affect the power tool's operation. If damaged, have the power tool repaired before use. Many accidents are caused by poorly maintained power tools.

- Keep cutting tools sharp and clean. Properly maintained cutting tools with cutting edges are less likely to stick and are easier to control.
- Use the power tool, accessories and tool bits etc., in accordance with these instructions and in the manner intended for the particular type of power tool, taking into account the working conditions and the work to be performed. Use of the power tool for operations different from intended could lead to a hazardous situation.

OPERATING PROCEDURES

Your heat gun has been designed for the following operations:

- Removing paint and paint residues from wood, metal and synthetics;
- Removing self-adhesive labels;
- Applying PVC labels;
- Moulding low-temperature materials, including acrylics and Perspex.
- Melting together synthetics, including materials and foils with a PVC layer;
- Shrink tubing;
- Heating pipe attachments and bowing pipes;
- Repairing skis, surf boards and similar sporting equipment.

Instructions for use:

- Aim the mouthpiece of the machine at the workpiece.
- Heat the material a few seconds before working it.
- For optimum result it is recommended to test the machine first on a small part of the workpiece.

■ STARTUP

The position of the switch controls both the ventilation fan speed and the heat gun output power of the gun.

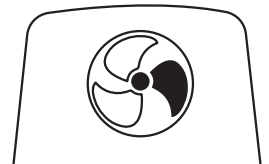

- To turn the tool on in low wind speed, slide the switch marked To adjust the temperature, use the master temperature control knob.

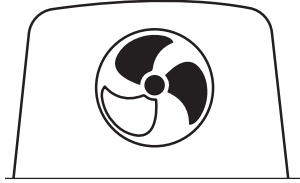

- To turn the tool on in medium wind speed, slide the switch marked To adjust the temperature, use the master temperature control knob.

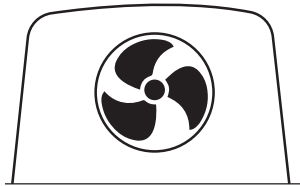



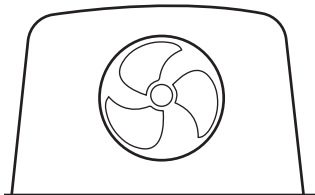

- To turn the tool on in high wind speed, slide the switch marked To adjust the temperature, use the master temperature control knob.

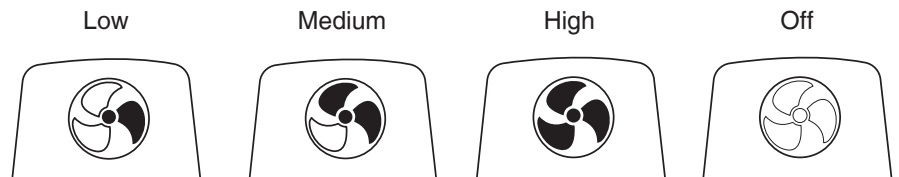

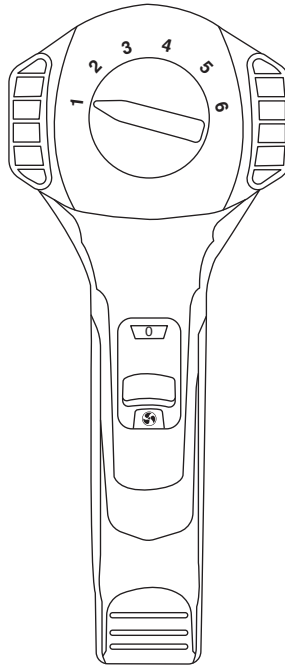
- To turn the tool off, slide the switch to the position marked.





Nozzle	Description	Purpose
	Glass protection nozzle	Protection windows when stripping frames
	Fish tail surface nozzle	Drying, thawing (heat spread over wider area)
	Concentrating nozzle	For decolorization of the seams, edges, corners, cracks and plaster pilasters / Edge banding in all woodcarving industry and MDF (for PVC tapes and melamine)
	Cone nozzle	Plastic welding and soldering

HEAT GUN

2000W





www.ronixtools.com